

**LOADER CRANES**

# CRANE TOOLS

**LIFETIME EXCELLENCE**



**ENGLISH | 2022/V01**



# OVERVIEW CONTENTS

## A - General

PALFINGER Crane Tools – Equipment for professionals	04 - 05
Express tools	06 - 07
Requirements for the crane	08 - 09

## B - Workman baskets

Workman basket CE-EN 280	10 - 11
Matrix for workman baskets	12 - 13
Retrofitting	14
Personal safety device	14
Workman basket NON-CE	15
Dimensioning	16
Emergency drive	17
Pull-in profiles	17

## C - Multifunctional adapter (MFA)

Overview	18 - 19
MFA-L	20 - 21
MFA-H	22 - 23
MFA-Jib	24 - 25

## D - Rotators

Overview	26 - 27
Possible combinations	28 - 29

## E - Grapples

Overview	30 - 31
HPX-grapple configuration options	32 - 33
Grapple configuration options	34 - 35

## F - Brick stack grapples

Overview	36 - 37
Brick stack grapple configuration options	38 - 41

## G - Pallet forks

Overview pallet fork	42 - 43
Pallet fork configuration options	44 - 45
Overview universal fork	46
Universal fork configuration options	47

## H - Container discharge units

Overview	48 - 49
Container discharge unit configuration options	50 - 51

## I - Earth augers

Overview	52 - 53
Possible combinations	54 - 55

## J - Lifting equipment

Hydraulic hook	56 - 57
Lifting accessory package	58
Barrier lifter	59
Car lifting devices	60 - 61
Manipulators	62 - 63
Special load attachment	64
Installation tip	65

## K - Weight measurement systems

Weight measurement systems	66 - 67
----------------------------	---------

# PALFINGER CRANE TOOLS

## EQUIPMENT FOR PROFESSIONALS

We know – our customers are professionals, and professionals are only satisfied with the best tools.

Our mission is to give you the tools that make your job faster, more efficient and safer. We want you to enjoy working with your crane and tools, and to be happy when you get into your vehicle when the job is done.

This feeling can only be achieved with a reliable tool that is perfectly matched to the loader crane and application. The Palfinger loader crane equipped with the tools from this catalog - the perfect package.



### VERSATILE APPLICATIONS

Equipped with the right tool, the crane is multifunctional and economical. Whether hydraulically or mechanically – PALFINGER offers a comprehensive range of additional equipment to make the loader crane a flexible and versatile tool.



### EXPRESS TOOLS

You need quickly a crane tool for a job? From now on you can order selected tools from our stock with a very short delivery time.



### INDIVIDUAL SOLUTIONS

Special jobs require special tools. To ensure your success – no matter how complex your job is - we offer not only numerous established special equipment but also the opportunity for individual solutions. Contact us and we will find the best solution together.



### MAXIMUM SAFETY

We are the only supplier on the market for years who offers a complete package of crane and workman basket which fulfills the high safety requirements of the EN 280 standard. Furthermore, you save costs if you buy a complete vehicle.

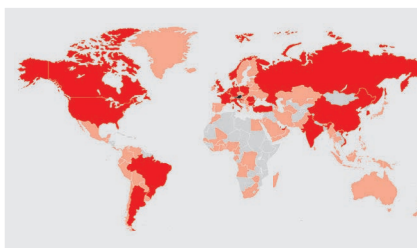

### SERVICE AND TECHNICAL SUPPORT

With around 4500 sales and service centers worldwide, PALFINGER offers a nationwide service network. The highly trained staff of our service partners provide prompt help.



### SPARE PARTS SUPPLY

Several spare parts centers worldwide guarantee a complete supply of spare parts. All original-spare parts are tested and fulfill the PALFINGER quality standard.

# EXPRESS TOOLS

You want to retrofit your loader crane with a crane tool and need it as quickly as possible?

Or something has broken down and you urgently need a quick replacement to accept the next job?

To help you in such situations, you have the option of purchasing selected attachments and suspension elements from stock.

Quick and easy.



## DIGGING GRAPPLE 350 L – PZG350G

Compact design and very good immersion behavior due to optimized shell geometry

- Load capacity 3000 kg
- Nominal capacity 350 l
- Max. operating pressure 320 bar
- Incl. Excavator teeth

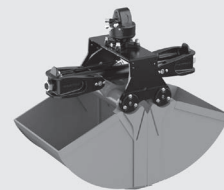

## HIGH VOLUME CLAMSHELL BUCKET 500 L – PZG500S-1

High handling capacity for all bulk materials

- Load capacity 3000 kg
- Nominal capacity 500 l
- Max. operating pressure 320 bar
- Incl. 2 welding hooks for hanging slings or chains

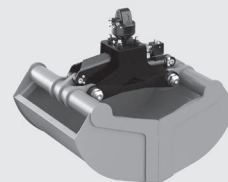

## PALLET FORK 2 T – PZP200

Robust and economical crane fork

- Load capacity 2000 kg
- Tine length 980 mm
- Usable height 1050 – 1650 mm
- Easy adjustment of effective height and tine distance





## CONNECTION PARTS

**UPPER SUSPENSION  
HEXAGONAL PROFILE –  
UL045**



**UPPER SUSPENSION  
COMPACT HEXAGONAL  
PROFILE – UL045K**



**UPPER SUSPENSION  
P-PROFILE –  
KLG060-BA**



**FLANGE ROTATOR –  
PZR450GF+S**



Flange rotator 4.5 t



Hose protection



Hose set  
4 hoses from  
crane to rotator

+

2 hoses from  
rotator to  
attachment

**FLANGE ROTATOR –  
PZR450G-68+S**



Flange rotator 4.5 t D68



Hose protection



Hose set  
4 hoses from  
crane to rotator  
+  
2 hoses from rotator  
to attachment

**CONNECTING PART ROTA-  
TOR | ATTACHMENT –  
PZZR450R-68**

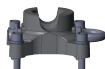

**QUICK CHANGER  
UPPER PART –  
PZZR450SV-OT  
LOWER PART –  
PZZR450SV-UT**





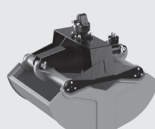
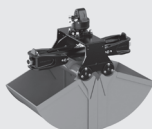

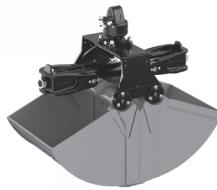
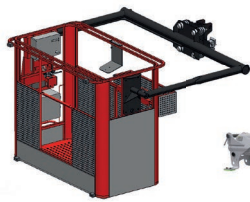

**LOAD HOOK  
ROTATOR –  
PZZR450LH-68**



# REQUIREMENTS FOR THE CRANE



	WORKMAN BASKET (EN280)	MFA-JIB	GRAPPLE	BRICK STACK GRAPPLE	FORK (HYDRAULIC)
Hydraulic supply	--	--	SL4 / T4 / T4I / J04	SL4 / T4 / T4I	SL4 / T4 / T4I / J04
Pressure limit on control valve	--	--	 --  GRDRU	 --  GRDRU	 --  GRDRU
Electric supply	AK VAK	--	--	--	--
Miscellaneous	SH / TEC Emergency lowering unit required	TEC PJMFA I TOOL	--	--	--

## TO BE OBSERVED

Many of the crane tools are equipped with an overpressure protection device. This protects the tool and the rotator from overpressure and thus from damage.

The Crane Tools catalog always states whether the additional device is supplied with an overpressure protection device. The following must be observed for devices without overpressure protection:





DISCHARGE UNIT	EARTH AUGER	BARRIER LIFTER	HYDRAULIC HOOK	CAR LIFTING DEVICE	MANIPULATOR
SL4/T4/T4I	SL2/T2	--	SL4/T4/T4I/J04	SL4   T4   T4I (SL4   T4   T4I)	SL4/T4/J04
-- GRDRU	RODRU 260	--	-- GRDRU	-- GRDRU	RODRU GRDRU
--	--	--	--	--	3x1,5 mm <sup>2</sup> (for change over valve)
--	--	--	--	--	RRC

**Operating pressure crane > maximum pressure rotator / crane tool**

- GRDRU => Maximum pressure of crane tool
- RODRU => Maximum pressure of rotator

**Operating pressure crane < maximum pressure rotator / crane tool**

- GRDRU => no limit necessary
- RODRU => no limit necessary

Information on the pressures can be found in the technical data on Paldesk or in the Crane Tools catalog.

# WORKMAN BASKET

## CE-EN 280

The PALFINGER EN 280 workman basket was specially developed for the use on SH and TEC loader cranes. Through the use of innovative technology, your PALFINGER crane becomes an aerial work platform and thus considerably expands the field of application of your crane vehicle. For years, we have been the only supplier on the market to offer the crane and workman basket as a complete system that complies with the EN 280 standard. This considerably simplifies the release process of the complete vehicle and saves you money. You don't know yet, if you will use workman baskets at a later stage? You can order your crane with a workman basket preparation and retrofit the workman basket if necessary – uncomplicated and without costly adaptation work.

### Advantages

- PALFINGER and TÜV approved crane and workman basket system according to the EN 280 standard
- Low dead weight for maximum reach
- Fast and ergonomic installation due to quick-change system
- Protected handrail on all sides
- Safe working with the optionally available personal safety device
- Lowering in an emergency with the available emergency drive

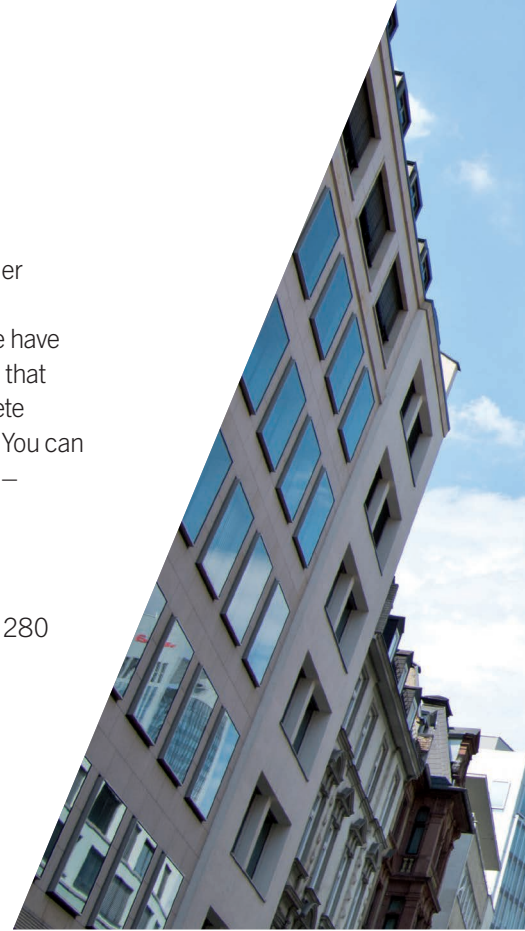

### BB040

#### Comfortable

- Comfort and safety at the highest level for **two people**
- Fine-controlling automatic leveling for the perfect balance
- Integrated toolbox for safe storage
- Largest possible workspace



### BB041

#### Compact

- Comfort and safety at the highest level for one person
- Slim design
- Fine-control automatic leveling for the perfect balance
- Integrated toolbox for safe storage
- Largest possible workspace



### BB042

#### Economical

- Easy working for **two people**
- Innovative and patented valve control for damped pendulum motion
- Optional Toolbox



TECHNICAL DATA	BB040	BB041	BB042
----------------	-------	-------	-------

Load capacity	[kg]	200	140	200
Permitted persons		2	1	2
Leveling		electro-hydraulic	electro-hydraulic	gravitation
Working angle	[°]	360	360	135
Dimensions WxDxH	[mm]	1400x700x1160	850x700x1160	1400x700x1160
Floor space	[m <sup>2</sup> ]	0.98	0.6	0.98
Electrical system	[V]	24	24	24
Emergency stop		●	●	●
Quick change system		●	●	●
Toolbox		●	●	○ HX6959
Dead weight	[kg]	200	172	145

● Standard   ○ Optional   -- Not available

# MATRIX

## FOR WORKMAN BASKETS

\* only BB041 possible  
\*\* only BB041 and BB042 possible

### CRANE TYPES

	Hydraulic extension on the crane								Hydraulic extension on the fly-jib					
	A	B	C	D	E	F	G	H	A	B	C	D	E	F
PK 10002 SH		●	●	●*										
PK 12502 SH		●	●	●**										
PK 14502 SH			●	●	●*									
PK 14502 SH B PJ 060									●**	●*				
PK 18502 SH			●	●	●									
PK 18502 SH B PJ 060									●	●				
PK 18502 SH C PJ 060									●	●*				
PK 23002 SH			●	●	●									
PK 23002 SH B PJ 060									●	●				
PK 23002 SH C PJ 060									●	●				
PK 27002 SH				●	●	●	●							
PK 27002 SH C PJ 060									●	●				
PK 27002 SH C PJ 080										●	●			
PK 27002 SH D PJ 060									●	●				
PK 27002 SH E PJ 060									●	●*				
PK 28.002 TEC 5				●	●	●	●**							
PK 28.002 TEC 5 C PJ090										●	●			
PK 28.002 TEC 5 D PJ090										●	●*			
PK 28.002 TEC 5 D PJ075									●	●				
PK 28.002 TEC 5 E PJ075									●	●*				
PK 29.502 TEC 7				●	●	●	●							
PK 29.502 TEC 7 C PJ090										●	●			
PK 29.502 TEC 7 D PJ090										●	●**			
PK 29.502 TEC 7 D PJ075									●	●				
PK 29.502 TEC 7 E PJ075									●	●*				
PK 28.502 TEC 5				●	●	●	●**							
PK 28.502 TEC 5 C PJ090										●	●			
PK 28.502 TEC 5 D PJ090										●	●*			
PK 28.502 TEC 5 D PJ075									●	●				
PK 28.502 TEC 5 E PJ075									●	●*				
PK 30.002 TEC 7				●	●	●	●							
PK 30.002 TEC 7 C PJ090										●	●			
PK 30.002 TEC 7 D PJ090										●	●**			
PK 30.002 TEC 7 D PJ075									●	●				
PK 30.002 TEC 7 E PJ075									●	●*				
PK 34002 SH				●	●	●	●							
PK 34002 SH C PJ 080										●	●			
PK 34002 SH D PJ 060									●	●				
PK 34002 SH D PJ 080										●	●			
PK 34002 SH E PJ 060									●	●				
PK 35.002 TEC 5				●	●	●	●							
PK 35.002 TEC 5 D PJ090										●	●			
PK 35.002 TEC 5 E PJ090										●	●**			
PK 35.002 TEC 5 F PJ075									●	●*				
PK 36.502 TEC 7				●	●	●	●							
PK 36.502 TEC 7 D PJ090										●	●			
PK 36.502 TEC 7 E PJ090										●	●			
PK 36.502 TEC 7 F PJ075									●	●**				
PK 35.502 TEC 5				●	●	●	●							
PK 35.502 TEC 5 D PJ090										●	●			
PK 35.502 TEC 5 E PJ090										●	●**			
PK 35.502 TEC 5 F PJ075									●	●*				
PK 37.002 TEC 7				●	●	●	●							
PK 37.002 TEC 7 D PJ090										●	●			
PK 37.002 TEC 7 E PJ090										●	●			
PK 37.002 TEC 7 F PJ075									●	●**				
PK 42002 SH				●	●	●	●							
PK 42002 SH D PJ 125											●		●	

**CRANE TYPES**

**Hydraulic extension on the crane**

**Hydraulic extension on the fly-jib**

	Hydraulic extension on the crane								Hydraulic extension on the fly-jib					
	A	B	C	D	E	F	G	H	A	B	C	D	E	F
PK 42002 SH E PJ 080										•	•			
PK 42002 SH F PJ 060									•	•				
PK 45.002 TEC 5				•	•	•	•							
PK 45.002 TEC 5 D PJ150											•		•	
PK 45.002 TEC 5 E PJ150											•		•	
PK 45.002 TEC 5 E PJ090										•	•			
PK 45.002 TEC 5 F PJ090										•	•			
PK 45.002 TEC 5 G PJ075									•	•*				
PK 48.002 TEC 7				•	•	•	•							
PK 48.002 TEC 7 D PJ150											•		•	
PK 48.002 TEC 7 E PJ150											•		•	
PK 48.002 TEC 7 E PJ090										•	•			
PK 48.002 TEC 7 F PJ090										•	•			
PK 48.002 TEC 7 G PJ075									•	•				
PK 53002 SH				•	•	•	•							
PK 53002 SH D PJ 125											•		•	
PK 53002 SH E PJ 125											•		•	
PK 53002 SH E PJ 080										•	•			
PK 53002 SH F PJ 080										•	•			
PK 55.002 TEC 5				•	•	•	•							
PK 55.002 TEC 5 E PJ150											•		•	
PK 55.002 TEC 5 F PJ090										•	•			
PK 55.002 TEC 5 F PJ150											•		•**	
PK 55.002 TEC 5 G PJ090										•	•*			
PK 58.002 TEC 7				•	•	•	•							
PK 58.002 TEC 7 E PJ150											•		•	
PK 58.002 TEC 7 F PJ090										•	•			
PK 58.002 TEC 7 F PJ150											•		•	
PK 58.002 TEC 7 G PJ090										•	•			
PK 65002 SH					•	•	•							
PK 65002 SH D PJ 170											•		•	
PK 65002 SH E PJ 125											•		•	
PK 65002 SH F PJ 125											•		•*	
PK 65002 SH F PJ 100											•	•		
PK 78002 SH					•	•	•							
PK 78002 SH D PJ 170											•		•	
PK 78002 SH E PJ 170											•		•	
PK 78002 SH E PJ 125											•		•	
PK 78002 SH F PJ 125											•		•	
PK 92002 SH						•	•	•						
PK 92002 SH E PJ 170											•		•	
PK 92002 SH F PJ 170											•		•	
PK 92002 SH F PJ 125											•		•	
PK 92002 SH G PJ 125											•		•	
PK 92002 SH G PJ 100											•	•		
PK 110002 SH						•	•	•						
PK 110002 SH F PJ 170											•		•	
PK 110002 SH G PJ 170											•		•	
PK 110002 SH G PJ 125											•		•	
PK 135.002 TEC 7			•		•	•	•	•						
PK 135.002 TEC 7 F PJ240													•	
PK 135.002 TEC 7 G PJ190													•	
PK 135.002 TEC 7 H PJ150													•	
PK 165.002 TEC 7						•	•	•						
PK 165.002 TEC 7 F PJ 300L														•
PK 165.002 TEC 7 G PJ 240													•	
PK 200002L SH					•		•							
PK 200002L SH G PJ 300L											•			•

# RETROFIT

If you would like to retrofit your SH or TEC crane with a workman basket according to EN 280, this is only possible with the preparation for a workman basket operation, offered by PALFINGER. In addition to the pull in part and the electrical preparation on the crane, the preparation also includes the necessary assembly parts for setting up an emergency drive. Only the emergency drive, a cable drum kit depending on the crane execution and the workman basket itself are necessary for retrofitting.



## EP1982

### Emergency drive (3 kW, max. 270 bar)

To ensure safe lowering of the workman basket in case of failure of the conventional hydraulic system, an emergency operation of the workman basket acc. EN 280 is required. Parts such as pressure compensator, check valve and battery switch are already included in the scope of delivery of the crane workman basket preparation. However, it's also possible to obtain a complete kit including these parts. (see page 14)

ATTENTION: The drive is exclusively designed for emergency and not for standard operation. The hydraulic and electrical connection must be made in accordance with the installation guidelines of PALFINGER. Please make sure that the specifications of the carrier vehicle are adhered to! When making electrical connections, pay attention to the appropriate cable cross-sections.



## KKF00028A

### Cable drum-Kit

If there are no hose trays mounted on the crane, the electrical supply to the workman basket must be additionally ensured with a cable drum. All necessary parts for the assembly including the cable drum itself are included in this kit.

# WORKMAN BASKET PERSONAL SAFETY EQUIPMENT

Complete your workman basket with our personal safety system, which is mandatory in many countries. The fall protection device and the safety harness recommended by PALFINGER offer optimum protection and wearing comfort.



## PZBB03

### Fall protection device (length 1.8 m) according to EN 360

- Revision-free in the whole EU
- With fall-indicator
- Especially for workman basket operation according to EN 280



## PZBB04

### Comfort security harness in H-design according to EN 361

- 2-point system (front and rear connection possible)
- Elastic DuraFlex belt
- Quick-release buckles on leg loops and chest belt

# WORKMAN BASKET NON-CE

The NON-CE version of the simple and robust PALFINGER workman baskets have been especially developed for use on hydraulic loader cranes and are used exclusively in countries where the EN 280 standard is not required.

## Advantages

- Expand the range of operation of loader cranes
- The optional quick-change system allows quick installation of the workman basket



B Workman baskets



## BB004

- Robust construction for **two people**
- Reduced to the essential
- Integrated toolbox for safe storage



## BB004B

- Robust construction for **two people**
- Built-in emergency stop button (power supply necessary)
- Integrated toolbox for safe storage



## BB052

- Weight-optimized aluminum basket for **two people**
- Reduced to the essential



## BB056

- Weight-optimized fiberglass basket for **two people**
- Reduced to the essential
- Integrated toolbox for safe storage

## TECHNICAL DATA

**BB004**
**BB004B**
**BB052**
**BB056**

Load capacity	[kg]	280	280	200	200
Permitted persons		2	2	2	2
Material		steel	steel	steel / Aluminum	steel / fiberglass
Leveling		gravitation	gravitation	gravitation	gravitation
Working angle	[°]	360	360	120	120
Dimensions BxTxH	[mm]	1000x694x1192	1000x694x1192	1400x710x1150	1450x900x1150
Floor space	[m <sup>2</sup> ]	0,6	0,6	0,8	0,8
Electrical system	[V]	--	--	--	--
Emergency stop		--	●	--	--
Quick change system		○ BZ456*	○ BZ456*	○ BZ456*	○ BZ456*
Toolbox		●	●	--	●
Dead weight	[kg]	190	190	101	105
Radio remote bracket		HXE3003 (SCANRECO S), KSS001B03 (SCRANRECO L), HXE9216 (PALCOM)		--	--

● Standard ○ Optional -- Not available \* for hexagonal profile

# GENERAL DIMENSIONING

PALFINGER recommends that the following calculation should be considered in order to determine the required minimum load capacity of the NON-CE crane



$$\frac{\text{reach - basket}}{\text{reach - crane}} \times \left( \text{weight pull in part} + \text{weight workman basket} + \frac{\text{Load capacity workman basket}}{\text{Load capacity crane acc. Load capacity label}} \times 1.5 \right) = \text{Required minimum load capacity of the crane during workman basket operation}$$

Total weight - basket [kg]  
Reach - basket [m]  
Reach - crane [m]  
Load capacity - crane [kg]  
LK [m]

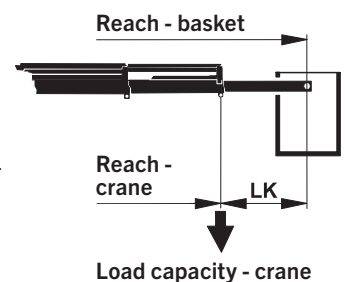
Weight basket + load capacity basket + weight pull in part  
Reach of the crane with workman basket  
Maximum reach of the crane without workman basket  
Load capacity of crane acc. Load capacity label  
Distance from the load hanger of the last extension boom to the center of gravity of the workman basket. This distance depends on the workman basket + pull in part.



**In order to ensure safety during workman basket operation**, it is also recommended to fully support the crane and to ensure stability throughout the working area. **The maximum crane speed** in work basket operation prescribed in EN 280 should also **not be exceeded!**

Speed	Movement
max. 0.4 m/s	 Vertical- and horizontal movements
max. 0.7 m/s	 Slewing movements (measured in the working basket at maximum reach)



# EMERGENCY DRIVE

To ensure a safe lowering of the workman basket in case of failure of the conventional hydraulic system, an emergency operation of the workman basket is also recommended for NON-CE cranes.

The emergency drive is available as a hydraulic kit for constant or variable pump for 24V. The hydraulic kit contains all necessary hydraulic components such as check valve, pressure compensator, etc.



Code	Description
KMG00210A	Workman basket emergency-drive kit for constant-pump cranes 24 V – 3 kW – max. 270 bar
KMG00211A	Workman basket emergency-drive kit for variable-pump cranes 24 V – 3 kW – max. 270 bar

The emergency unit is also available as a loose part

Code	Description
EP1982	Emergency drive 24 V – 3 kW – max. 270 bar
EP2022	Emergency drive 12 V – 3 kW – max. 270 bar

ATTENTION: The drive is exclusively designed for emergency and not for standard operation. The hydraulic and electrical connection must be made in accordance to the installation guidelines of PALFINGER. Please make sure that the specifications of the carrier vehicle are adhered to! When making electrical connections, pay attention to the appropriate cable cross-sections.

# PULL IN PARTS

PALFINGER offers suitable pull in parts for the mechanical connection of a NON-CE workman basket on the crane. The quick-change system allows a convenient coupling and uncoupling of the workman basket on the crane.

Code	Quick change device for workman basket	Quick change device with	Quick change device without	Inside dimensions A [mm]	Extension boom B [mm]	Use	Weight [kg]
BB040ES01AU	+BZ456	●		123	62		23
BB013-10V1			●	123	62		22
BB040ES02AU	+BZ456	●		155	79		26
BB013-15V1			●	155	79		22
BB040ES03AU	+BZ456	●		188	96	crane < 35 mt / Fly Jib	26
BB040ES04AU	+BZ456	●		188	96	crane > 35 mt	26
BB013-16V1			●	188	96		28
BB040ES05AU	+BZ456	●		224	120	crane	29
BB040ES13AU	+BZ456	●		224	120	Fly-Jib	42
BB013-17AV1			●	224	116		30
BB040ES06AU	+BZ456	●		260	138	crane	30
BB040ES14AU	+BZ456	●		260	138	Fly-Jib	43
BB013-18V1			●	260	138		33
BB040ES08AU	+BZ456	●		296	158		34
BB040ES09AU	+BZ456	●		237	146		38
BB040ES15AU	+BZ456	●		282	170		41
BB040ES16AU	+BZ456	●		327	198		43

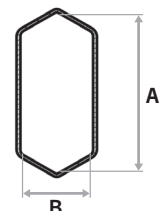
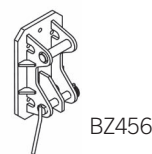
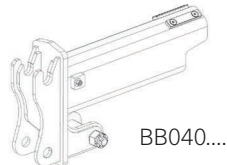
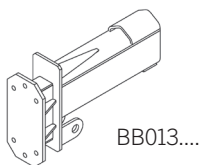

It is possible that adaptations are necessary on the pull in part on some crane versions.

# MULTIFUNCTIONAL ADAPTER

The PALFINGER loader crane has always been a multifunctional working tool and is successfully used by our customers for a wide range of tasks. A variety of available attachments support this feature, as the crane can be perfectly equipped for the job. In order to facilitate the change between the various applications and to make it more ergonomic, PALFINGER has developed MFA, short for multifunctional adapter, for the TEC crane range.

The advantage for the user is the standardized interface at the crane tip. As a result, a lesser manual effort is necessary for changing attachments, which significantly increases safety, efficiency and comfort.

## Advantages

- Efficient change between different tools
- Minimum effort is required when changing attachments
- Expansion of the application possibilities of the crane
- Standardized mechanical interface

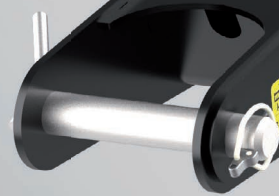

## MFA - LOGIC

Depending on the expected load on the MFA, two independent MFA series optimized for the application were created. The two series, MFA-L (light) and MFA-H (heavy), differ fundamentally in their design and are not compatible with each another. In order to increase user-friendliness, the selection of the correct tool or set-up state is made easier by visual coding.



## MFA - LOAD ATTACHMENT

The MFA load attachment is suitable for the simple connection of hooks, rotators and other crane tools. The increased distance to the extension boom ensures trouble-free working in all arm positions.



## MFA - WORKMAN BASKET

To ensure quick and easy coupling with the PALFINGER - EN280 workman baskets, the workman baskets BB040 / BB041 / BB042 are also available with the connection for the MFA.



C MFA



### MFA - PULLEY HEAD

Ideally, the appropriate pulley heads are ordered with the crane and the MFA. The individual components can also be ordered later. There is a variety of matching pulley heads available for the MFA, allowing easy and time-saving docking.



### MFA - INSTALLATION TIP

The perfect tool for crane operations in confined spaces. Whether machine handling or the loading of goods through windows or doors – with the PALFINGER MFA mounting tip, you can expand the possible applications of your crane. As with any MFA attachment, simple and time-saving docking is possible.



### MFA - JIB

The MFA-JIB is available in a fixed and a tiltable version. The use of this MFA connection increases the range of your crane and allows you to work over interfering edges and allows exceptional operations. The software function "TOOL" ensures the integration of the MFA-JIB into the electronic stability control system HPSC.

# MFA-L-RETROFIT

You want to retrofit your existing TEC – crane with a MFA?

Here you select the MFA required for your crane version – based on the extensions on the crane or fly jib. The visual coding on MFA and its tools will help you to choose the available combinations.

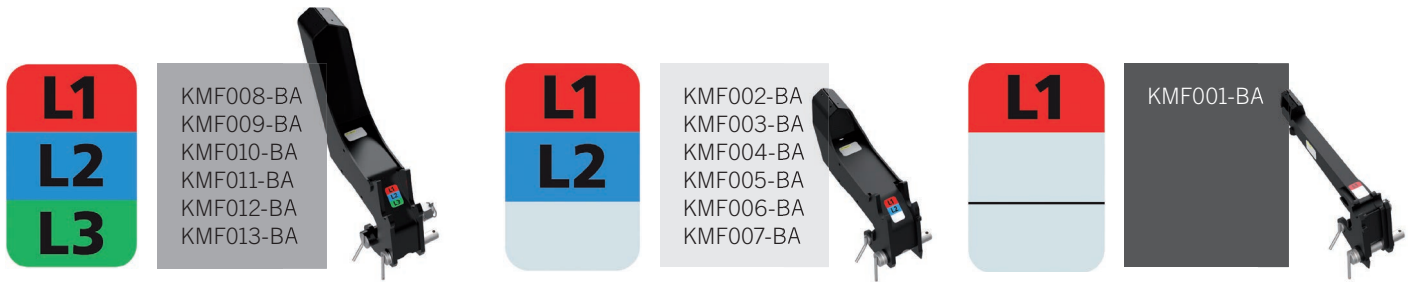

## CRANE TYPES

### Hydraulic extension on the crane

	A	B	C	D	E	F	G	H
PK 28.002 TEC								
PK 28.502 TEC								
PK 29.502 TEC								
PK 30.002 TEC	KMF009-BA	KMF008-BA	KMF007-BA	KMF006-BA	KMF005-BA	KMF004-BA	KMF003-BA	--
PK 35.002 TEC								
PK 35.502 TEC								
PK 36.502 TEC								
PK 37.002 TEC								
PK 45.002 TEC								
PK 48.002 TEC	KMF010-BA	KMF009-BA	KMF008-BA	KMF007-BA	KMF006-BA	KMF005-BA	KMF004-BA	--
PK 55.002 TEC								
PK 58.002 TEC								
PK 135.002 TEC	--	--	KMF012-BA	--	KMF010-BA	KMF009-BA	KMF008-BA	KMF007-BA
PK 165.002 TEC	--	--	KMF013-BA	--	KMF011-BA	--	KMF009-BA	KMF008-BA

## FLY JIB TYPES

### Hydraulic extension on the fly-jib

	A	B	C	D	E	F
PJ 075	KMF003-BA	KMF002-BA				
PJ 090	KMF003-BA	KMF002-BA	KMF001-BA			
PJ 150	--	--	--	--	KMF001-BA	
PJ 190	--	--	--	--	KMF002-BA	
PJ 240	--	--	--	--	KMF003-BA	

\* 4.5 t MFA-pulley head not allowed for this combination

# OPTIONS

## Load attachment

11,5 t

18 t

25 t



**L1**

KLG051-BA

**L2**

KLG052-BA

--

Trouble-free working in all arm positions.  
For connecting hooks, rotators and other crane tools.

## Workman basket connection

BB040

BB041

BB042



**L1**

BB040K01-BA

**L1**

BB040K01-BA

**L1**

BB042K01-BA

You can already order your PALFINGER EN 280 work basket with the suitable MFA connection ex factory under the **option –P**. For any retrofits, we offer the connection console as a single part.

## Pulley heads

1,5 t

2,5 t

3,5 t

4,5 t



STRAN 1

--

**L1**

KUR279-BA\*

**L1**

KUR232-BA\*

--



STRAN 2

--

**L1**

KUR296-BA

**L2**

KUR233-BA

**L3**

KUR224-BA



STRAN 4

--

--

--

--

Ideally, the winch application is configured with the crane. Alternatively, the MFA pulley heads can also be ordered separately.

\* Tiltable pulley head for use up to KMF003-BA.

 In addition to the visual coding, the technical data must always be observed with regard to the installation of the cable winch components.

## Installation tip

2 t

3 t



**L1**

KLG108-BA

**L2**

KLG075-BB

On request, we can offer other models tailored to your application.

Ideal for working through window or door openings due to the offset load-bearing point. The MFA installation tip is an interchangeable load handling attachment acc. to EN 13155 and not integrated in the overload system of the crane. The maximum permissible load that is indicated on the installation tip must not be exceeded.

## Adapter

Earth auger



**L1**

KLG069-BA

--

--

--

On request, we can provide you with special adapters for other applications and tools.

# MFA-H-RETROFIT

The MFA-H series is designed for higher load applications such as four-line winch operation for example. As with the MFA-L, choose here the MFA required for your crane version – based on the Extension on the crane or JIB. The visual coding on MFA and its tools helps you to choose the available combinations.



KMF018-BA  
KMF019-BA  
KMF020-BA  
KMF021-BA  
KMF022-BA  
KMF023-BA

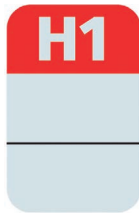

KMF014-BA  
KMF015-BA  
KMF016-BA  
KMF017-BA



## CRANE TYPES

## Hydraulic extension on the crane

	A	B	C	D	E	F	G	H
PK 28.002 TEC	KMF019-BA	KMF018-BA	KMF017-BA	KMF016-BA	KMF015-BA	KMF014-BA	--	--
PK 28.502 TEC								
PK 29.502 TEC								
PK 30.002 TEC								
PK 35.002 TEC								
PK 35.502 TEC	KMF020-BA	KMF019-BA	KMF018-BA	KMF017-BA	KMF016-BA	KMF015-BA	KMF014-BA	--
PK 36.502 TEC								
PK 37.002 TEC								
PK 45.002 TEC								
PK 48.002 TEC								
PK 55.002 TEC	--	--	KMF022-BA	--	KMF020-BA	KMF019-BA	KMF018-BA	KMF017-BA
PK 58.002 TEC								
PK 135.002 TEC								
PK 165.002 TEC	--	--	KMF023-BA	--	KMF021-BA	KMF020-BA	KMF019-BA	KMF018-BA

# OPTIONS

## Load attachment



11,5 t

18 t

25 t

--



KLG053-CA



KLG053-BA

Trouble-free working in all arm positions.  
For connecting hooks, rotators and other crane tools.

## Workman basket connection



BB040

BB041

BB042



BB040K02-BA



BB040K02-BA



BB042K02-BA

You can already order your PALFINGER EN 280 work basket with the suitable MFA connection ex factory under the **option –P**. For any retrofits, we offer the connection console as a single part.

## Pulley heads

1,5 t

2,5 t

3,5 t

4,5 t



STRAN 1

--

--

--

--



STRAN 2

--



KUR384-BA



KUR245-BA



KUR246-BA



STRAN 4

--



KUR234-BA



KUR225-BA



KUR226-BA

Ideally, the winch application is configured with the crane. Alternatively, the MFA pulley heads can also be ordered separately.

 In addition to the visual coding, the technical data must always be observed with regard to the installation of the cable winch components.

## Installation tip

6 t



KLG077-BA

On request, we can offer other models tailored to your application.

Ideal for working through window or door openings due to the offset load-bearing point. The MFA installation tip is an interchangeable load handling attachment acc. to EN 13155 and not integrated in the overload system of the crane. The maximum permissible load that is indicated on the installation tip must not be exceeded.

## Adapter

On request, we can provide you with special adapters for other applications and tools.

# MFA-JIB

"More reach" is probably the most requested customer requirement that reaches us. We are doing our best with the new MFA-Jib to expand your application possibilities.

The main advantages of the PJM020 are more than 5 meters of additional reach and the ability to get over additional interference edges. If you equip the MFA-Jib with a pulley head, it is possible to work in winch operation mode.

The MFA-JIB is an interchangeable load handling device complies with EN 13155 and can be easily and conveniently retrofitted onto provided crane/fly jib combinations.

It can be integrated into the electronic stability system of the crane with the software function "TOOL".

## PJM020

### TECHNICAL DATA

### PJM020

Lifting moment	[mt]	1.84
Max. reach	[m]	5.25
Max. load	[kg]	650
Painting		RAL 7001
Weight	[kg]	100







# OPTIONS

CODE	DESCRIPTION
------	-------------

S2.5	prepared for winch operation 2.5 t
S3.5	prepared for winch operation 3.5 t
S4.5	prepared for winch operation 4.5 t
SRC	prepared for synchronised rope control

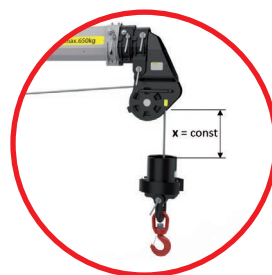

## ADJ

manual angle adjustment  
 +20° / 0° / -20° / -40° / -60°  
 The optionally available angle adjustment device makes it possible to overcome interference edges for special operations.



## KMG07490A

Parking console for easy, space-saving and secure storage of the MFA-JIB, above the crane base mounted crane tank. For the cranes PK 135.002 TEC / PK 165.002 TEC

## TOOL-RACK

Transport rack for safe stowage including all winch parts

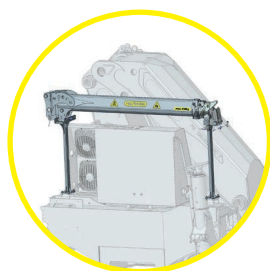

# ROTATORS

Rotators from PALFINGER impress with their high performance and durability combined with a compact design. Combined with the crane attachments offered by PALFINGER, you receive a perfectly coordinated total solution - optimum safety and maximum efficiency.

The applied "gerotor" principle makes it possible to build very compact and effective rotators that impress with their precise start and stopping behavior.

This prevents, for example, a rotation of the grapple when digging or makes a counter-control when manipulating long goods unnecessary.



## PRODUCT FEATURES

- Precise start and stop behavior (without countersteering)
- Payloads from 3 t up to 10 t
- Integrated pressure relief valves to prevent overloading
- High torque at low speed for precise positioning of loads and crane tools
- Two swivel ball bearings for safe absorption of compressive, tensile and bending loads
- Forged, one-piece flange shaft
- endless rotary motor with integrated oil passage

# ECTC

EFFICIENT CRANE TOOL COUPLING

# CRANE CONNECTION VARIANTS

In order to make it easier for you to choose the connection between crane and tool, we have put together various connection packages. You can simply select these with your additional device.

For the operation of an additional device

## FLANGE ROTATOR PACKAGE FLANGE

The package consists of:

- Flange rotator PZR450GF, payload 4500 kg, torque 850 Nm, bending moment 3000 Nm
- Upper suspension according to the crane version
- Hose protection to prevent damage of the hydraulic connections
- Connecting hoses to the crane incl. screw couplings



Ideally suited for the operation of several additional devices

## SHAFT ROTATOR PACKAGE SHAFT

The use of a shaft rotator makes it easy to switch between different accessories such as crane fork, brick stack grapples or clamp shell buckets.

The package consists of:

- Shaft rotator PZR450G-68, shaft diameter 68 mm, payload 4500 kg, torque 850 Nm, bending moment 3000 Nm
- Upper suspension according to the crane version
- Hose protection to prevent damage of the hydraulic connections
- Connecting hoses to the crane incl. screw couplings



## PRE-SHAFT

Preparation for shaft rotator

Mounted on the attachment, allows operation with a shaft rotator and ensures easy switching between different attachments. If the crane is already equipped with a rotator, the attachment can also be equipped only with the preparation.

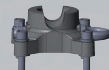

## QUICK-KIT

Quick change device (load 4000 kg)

For an even more efficient switching between different tools, a quick-change device is also available to the shaft rotator. The mechanical coupling and closing is effected by the rotary motion of the rotator. To disconnect, the operator only has to manually open the locking device of the quick-change system and operate the rotary motor. You can change easily and fast between e. g. grapple and brick stack grapples. If the rotator on the crane is already equipped with a quick-change system, the attachment can only be equipped with PRE-QUICK preparation.

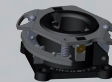

## SHAFT-HOOK

Load hook  
Payload 4500 kg

Rigid load hook. The perfect tool for positioning all your loads.

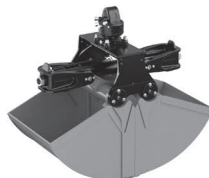

## QUICK-HOOK

Load hook  
Payload 4000 kg

Rigid load hook. The perfect tool for positioning all your loads.



more efficient, easier, safer exactly these characteristics distinguish the new fully hydraulic Tool changer. Get in touch with us to equip your cranetool with the ECTC.

## YOUR ADVANTAGES

- simple and safe change without manual activity by the operator
- Fully hydraulic tool change within a few seconds
- compact and robust construction
- Convenient change between various crane tools



## PZZR-ECTC11

Rotator  
Changeover valve  
Quick change top  
Hose protection

## PZZR-ECTC02

Quick change lower part (for hydraulic attachments)

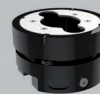

## PZZR-ECTC04

Quick change lower part (for mechanical attachments)

## PZZR-ECTC03

Quick change lower part with load hook



# ROTATORS COMBINATIONS

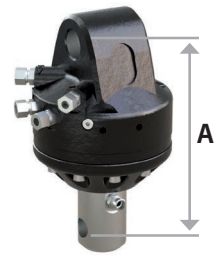
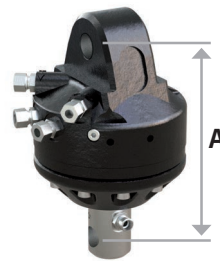

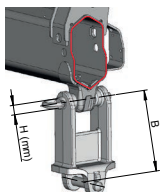
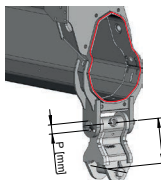
OPTION	DESCRIPTION	CODE	3 t PZR300G	4.5 t PZR450G-68
<b>Basic data</b>	Connection		Shaft Ø 49,5 mm	Shaft Ø 68 mm*
	Working pressure max. [bar]		370	370
	Overpressure protection		●	●
	Recommended rate of flow [l/min]		25 – 40	25 – 40
	Torque [Nm]		850	850
	Bending moment [Nm]		1750	3000
	Installation height A [mm]		229	242
	Weight [kg]		24	26
	Upper suspension		depending on crane	depending on crane
		H25 H30 H43	UL167 (B 170 mm) UL168 (B 170 mm) --	-- UL045 (B 263 mm) UL045K (B 173 mm) UL045-42 (B 253 mm)
		P30 P43	-- --	KL060-BA (B 150 mm) KL062-BA (B 150 mm)
<b>Additional equipment</b>	Connection hoses			
	Crane to rotator (2 pcs.) - length 900 mm		BL462-R	BL462-R
	Crane to rotator (4 pcs.) - length 900 mm		BL462	BL462
	Crane to rotator (4 pcs.) - length 1200 mm		BL513	BL513
	Rotator to additional device (2 pcs)		BL463	BL463
	Hydraulic plug-in couplings			
	Complete kit	2RO-PK	BL981-PK	BL981-PK
	Mobile parts (2 pcs.)	2RO-L	BL981-L	BL981-L
	Fixed part (2 pcs.)	2RO-R	BL981-F	BL981-F
	Hose protection <sup>4</sup>		--	PZZR450S
Connecting piece <sup>5</sup>	PRE-SHAFT	--	PZZR450R-68	
Load hook <sup>6</sup>	SHAFT-HOOK	--	PZZR450LH-68	
Rigid link <sup>7</sup>	SHAFT-LINK	--	PZZR450-A	
Quick changer - package	QUICK-KIT	--	PZZR450SV-PK	
Quick changer - upper part <sup>8</sup>	SHAFT-QUICK	--	PZZR450SV-OT	
Quick changer - lower part <sup>9</sup>	PRE-QUICK	--	PZZR450SV-UT	
Quick changer - hook <sup>10</sup>	QUICK-HOOK	--	PZZR450-A/LH	

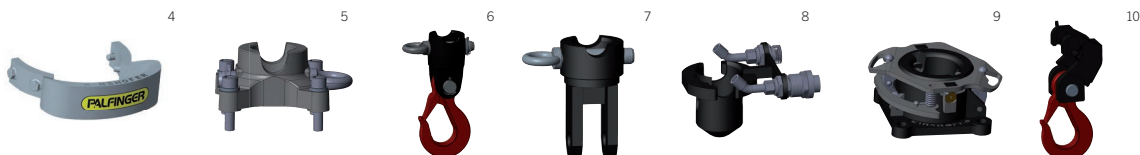

● Standard ○ Optional -- Not available \* further diameters available on request

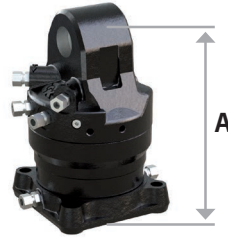
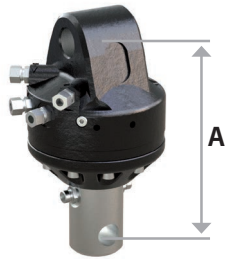

<b>t</b>	<b>6 t</b>		<b>10 t</b>
<b>PZR450GF</b>	<b>PZR601G</b>	<b>PZR601GF</b>	<b>PZR1000GF</b>
Flange □ 140 mm 370 ● 25 – 40 850 3000 220 26	Shaft Ø 68 mm 370 ● 25 – 40 1000 4500 286 32	Flange □ 140 mm 370 ● 25 – 40 1000 8500 254 34	Flange □ 140 mm 370 ● 25 – 40 2000 12000 313 65
depending on crane	depending on crane	depending on crane	depending on crane
-- UL045 (B 263 mm) UL045K (B 173 mm) UL045-42 (B 253 mm)	-- UL135 (B 278 mm) UL135K (B 245 mm) UL135-42 (B 268 mm)	-- UL135 (B 278 mm) UL135K (B 245 mm) UL135-42 (B 268 mm)	-- -- UL153-42 (B 370 mm)
KLG060-BA (B 150 mm) KLG062-BA (B 150 mm)	KLG063-BA (B 150 mm) KLG064-BA (B 150 mm)	KLG063-BA (B 150 mm) KLG064-BA (B 150 mm)	-- --
-- BL462 BL513 BL463	BL462-R BL462 BL513 BL463	-- BL462 BL513 BL463	-- BL462 BL513 BL463
	BL9 81-PK BL981-L BL981-F		
PZZR450S	PZZR601S	PZZR601S	--
--	PZZR601R-GA	--	--
-- --	PZZR601LH-W --	-- --	-- --
-- -- -- --	PZZR601SV-PK PZZR601SV-OT PZZR601SV-UT PZZR601-A/LH	-- -- -- --	-- -- -- --

# GRAPPLES

The classic crane tool. Regardless of whether handling or easy digging – we offer the right grab for every application. Proven technology ensures high reliability and efficiency.

A multitude of options also gives you the opportunity to optimally equip your grapple to your daily requirements.



## HPX GRAPPLE

### The all-rounder

- Universal clamshell grab for daily use
- Easy shell changing within 10 min
- Constant clamping force over the entire gripping process
- Low maintenance
- Longer life at lower operating costs
- No protruding components



## DIGGING GRAPPLE

### Solid

- Maximum loading height due to compact design
- Very good immersion behavior due to optimized shell geometry
- Long life due to high strength cutting edge material

## SPECIAL GRAPPLES

### Individually

In addition to the standard models, Palfinger offers a large number of special solutions on request.

### Grapple for Z-crane





## UNIVERSAL GRAPPLE

### Versatile

- Clamshell grab with laterally open shells for universal use.
- For simple digging, the handling of both bulk and bulky goods



## HIGH VOLUME CLAMSHELL BUCKET

### Fast

- The clamshell bucket for all handling operations
- Good accessibility allows lateral filling by hand
- High turnover rate

Rail grapples



Orange peel grapple



Grapples with vertical cylinders

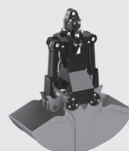

Grapples for small cranes



# HPX-GRAPPLE CONFIGURATION OPTIONS

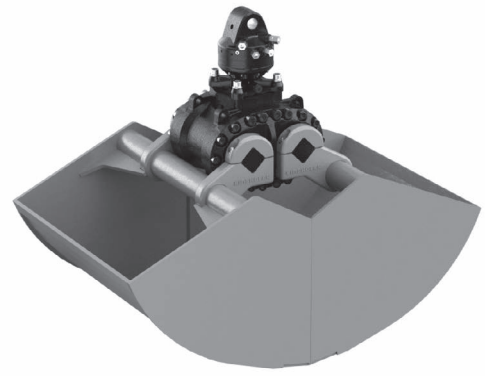

## HPX – DRIVE UNIT

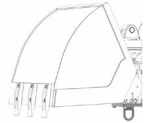
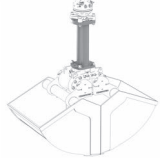
OPTION	DESCRIPTION	CODE	HPX	HPX hd
Basic data	Load capacity [kg]		3000	3000
	Working pressure max. [bar]		320	320
Additional equipment	Overpressure protection		●	--
	Recommended rate of flow [l/min]		40 – 75	40 – 75
	Closing force max. [kN]		20	30
	Weight [kg]		160	195
	Central hook		CENTH	<input type="checkbox"/>
Grab extension		GREX	length [mm]	
			<input type="checkbox"/>	<input type="checkbox"/>

## HPX – CRANE CONNECTION

**FHPX**  
For the operation of an additional device



**SHAFT**  
Ideally suited for the operation of several additional devices



**PRE-SHAFT**

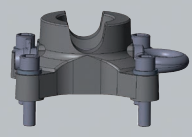

**QUICK-KIT**





**SHAFT-HOOK**



**QUICK-HOOK**













# HPX – EXCHANGEABLE SHELLS

OPTION	DESCRIPTION	CODE	HPX		HPX hd				
<b>CLAMSHELL BUCKETS</b>									
<b>Nominal volume</b>		095 L	G095	○	90	400	--	--	
		150 L	G150	○	120	600	--	--	
		200 L	G200	○	130	400	○	140	400
		250 L	G250	○	145	500	○	170	500
		325 L	G325	○	160	600	--	--	
		350 L	G350	○	165	650	○	200	650
		450 L	G450	○	180	800	○	225	800
		550 L	G550	--	--	--	○	265	1000
<b>UNIVERSAL CLAMSHELL BUCKETS</b>									
<b>Nenninhalt</b>		250 L	U250	○	215	570	--	--	
		300 L	U300	○	235	670	○	240	670
		400 L	U400	○	255	820	○	260	820
		450 L	U450	--	--	--	○	275	920
		500 L	U500	○	285	1020	○	295	1020
<b>Additional equipment*</b>	Screwable excavator teeth	DTEETH**	--	--	--	--	--		
	Scrapers	EJECT	○			○			
	wear plates	WEARE	○			○			
	weld-on hook	WHOOK02	○			○			
	hydraulic plug in couplings	2RO-PK	○			○			
	rail adapter	P-CRAIL	○			○			
	compression rails	CRAIL	○			○			
	side plates (only for universal shells)	SWALL	○			○			
	Special color RAL	RAL_____	○			○			
<b>FURTHER SHELLS</b>									
Hay and forest		0,20 m <sup>2</sup>	H020	○	95	670	--	--	
		0,40 m <sup>2</sup>	H040	○	160	940	○	195	940
Rock		0,16 m <sup>2</sup>	S016	○	75	400	--	--	
		0,35 m <sup>2</sup>	S035	--	--	--	○	135	400
Timber		0,16 m <sup>2</sup>	T016	○	75	400	○	90	400

● Standard ○ Optional -- Not available \* Details see page 28  
 \*\* Standard on clamshell buckets

# GRAPPLE

## CONFIGURATION

## OPTIONS

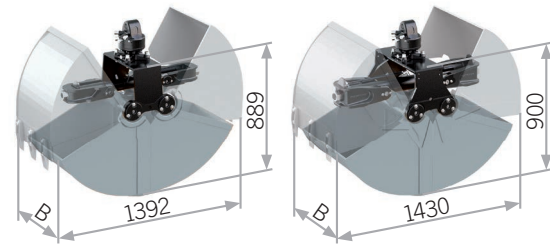

OPTION	DESCRIPTION	CODE	DIGGING GRAPPLE			
			PZG-G		PZG-G <b>hd</b>	
<b>Basic data</b>	Load capacity [kg]		3000		3000	
	Working pressure max. [bar]		320		320	
	Overpressure protection		--		--	
	Recommended rate of flow [l/min]		40 – 75		40 – 75	
	Closing force max. [kN]		20		30	
<b>Nominal volume</b>	150 L	CAP150	○ 185	325	--	
	200 L	CAP200	○ 195	400	○ 265	400
	250 L	CAP250	○ 220	500	○ 285	500
	300 L	CAP300	--		--	
	350 L	CAP350	○ 240	650	○ 310	650
	400 L	CAP400	--		--	
	450 L	CAP450	○ 275	800	○ 340	800
	500 L	CAP500	--		--	
	550 L	CAP550	○ 290	1000	○ 375	1000
	600 L	CAP600	--		--	
	650 L	CAP650	--		○ 410	1200
	1000 L	CAP1000	--		--	
	<b>Additional equipment</b>	Screwable excavator teeth	DTEETH		●	
Scrapers		EJECT		○		○
wear plates		WEARE		○		○
weld-on hook		WHOOK02		○		○
hydraulic plug in couplings		2RO-PK		○		○
compression rails		CRAIL		○		○
side plates		SWALL		--		--
Special color RAL		RAL__		○		○
<b>Crane Connection*</b>				Weight [kg]		Weight [kg]
		FLANGE	○	39	○	39
		SHAFT	○	40	○	40
		PRE-SHAFT	○	3	○	3
		SHAFT-HOOK	○	12	○	12
		PRE-QUICK	○	7	○	11
		QUICK-KIT	○	12	○	18
		QUICK-HOOK	○	7	○	14



● Standard ○ Optional -- Not available \* Details see page 27

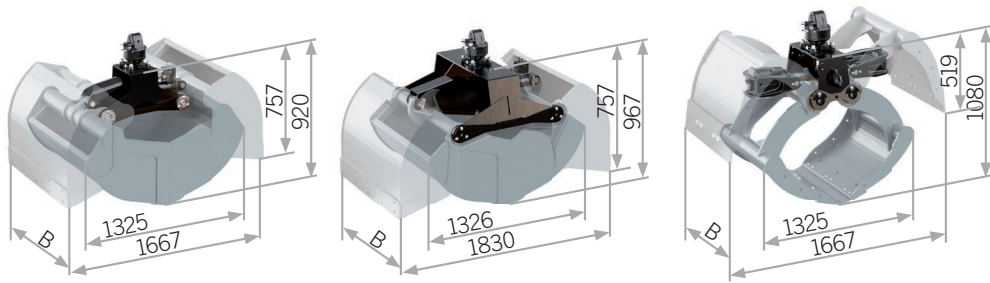

## HIGH VOLUME CLAMSHELL BUCKET

## UNIVERSAL GRAPPLE

## ADDITIONAL EQUIPMENT

### PZG-S

### PZG-S *hd*

### PZG-U

3000		3000		3000	
320		320		320	
●		●		--	
40 – 75		40 – 75		40 – 75	
20		28		28	
Weight [kg]	Overall width [mm]	Weight [kg]	Overall width [mm]	Weight [kg]	Overall width [mm]
--		--		--	
--		--		--	
--		--		○ 340	570
○ 315	640	○ 370	500	○ 355	670
--		--		--	
○ 345	800	○ 430	800	○ 380	820
--		--		○ 390	920
○ 370	1000	○ 475	1000	○ 410	1020
--		--		--	
--		--		○ 440	1220
--		○ 515	1200	--	
--		○ 595	1200	--	
○		○		○	
--		--		--	
○		○		●	
●		●		●	
○		○		○	
○		○		○	
--		--		○	
○		○		○	
Weight [kg]		Weight [kg]		Weight [kg]	
○ 39		○ 39		○ 39	
○ 40		○ 40		○ 40	
○ 3		○ 3		○ 3	
○ 12		○ 12		○ 12	
○ 7		○ 11		○ 11	
○ 12		○ 18		○ 18	
○ 7		○ 14		○ 14	

### DTEETH

#### Excavator teeth

Easy to change, screwable excavator teeth

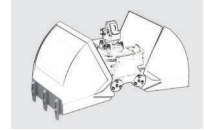

### EJECT

#### Ejector

Ejectors automatically clean, during the opening process, the insides of the shells of adhering materials, such as e.g. clay.

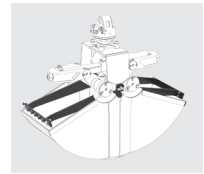

### WEARE

#### Wear edges

To protect the horizontal cutting edges.

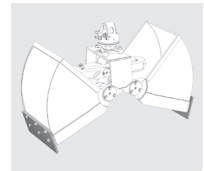

### WHOOK02

#### Welding hooks

For hanging slings or chains. Max. load per hook is 1000 kg



### CRAIL

#### Compression rails

for loading plates, curbs or similar

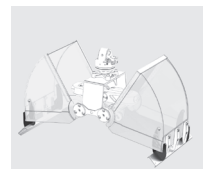

#### P-CRAIL

#### Adapter for compression rails

allows the fixing of the compression rails.

compression rails set  
**CR072** (length 720 mm)  
**CR100** (length 1000 mm)



### SWALL

#### Sidewalls

Additional sidewalls screwed



### RAL\_\_\_\_\_

#### Special color RAL

Color different from standard color RAL7001



# BRICK STACK GRAPPLES

The technically advanced brickstack grapples are the ideal attachments for the handling of palletized as well as unpaletted goods. Compared to the classic pallet fork, the unloading time, for example of a building material transporter, can be significantly reduced. The adjustable plunge depths and the optimized opening widths make it possible to load individual concrete elements as well as complete brick pallets. Due to the low-wear rubber inserts in the pressure rails, the pliers are particularly easy to maintain.



## PARALLEL OPENING

### Versatile

PZS

- Highest security
- Fixed or adjustable plunge depths
- Due to the large number of different pressure rails, the brick stack grapple can be perfectly matched to the material to be manipulated.



F Brick stack grapples



## SCISSOR OPENING

**Compact**  
PZS-S

- Compact design
- Fixed plunge depth
- Versatile use with opening widths from 40 - 1500 mm
- Pick up of single stones and big bags possible



## PARALLEL OPENING

**Simple**  
PZS321

- Simple, robust construction
- Flexibility because of adjustable plunge depth

**Attention!**

Not released for the CE countries.

# BRICK STACK GRAPPLES

## CONFIGURATION OPTIONS



OPTION	DESCRIPTION	CODE	PZS		
<b>Basic data</b>	Working pressure max. [bar]		370		
	Overpressure protection		●		
	Recommended rate of flow [l/min]		25 – 75		
			Load capacity [kg]**	Opening width [mm]	Weight [kg]
	<b>Fix</b>				
<b>Plunge depth</b>	850 mm	FIX085	○ 2200	400 – 1400	240
	1000 mm	FIX100	○ 2000	400 – 1400	250
	1300 mm	FIX130	○ 1600	400 – 1400	260
	<b>Variable</b>				
	1100 / 1650 mm	VAR165	○ 1900 / 1350	400 – 1400	295
<b>Additional equipment</b>	Opening width 1800 mm	OW1800		○	
	Pendulum brake	PENDLB		○	
	Tilting device for reducing the vehicle height	UKV		○	
	Height reduction link for reducing the vehicle height	KA		○	
	Spring-loaded guide rails to stabilize the upper row of stones	2RO-PK		○	
	Gripping width narrowing by 200 mm	SGRAIL		○	
	adapter for concrete pipes	GV200		○	
	Special color	ADRING		○	
	Sonderfarbe	RAL_____		○	
	<b>Compression rail set</b>	With smooth rubber insert	A29	720 ○	length 1000 ●
Spring-loaded guide rails for stabilizing the top layer of the stack		A32	--	○	○
With two rubber inserts blocked out at the top, smooth at the bottom		A39	○	○	○
<b>Crane connection*</b>					Weight [kg]
		FLANGE		○	39
		SHAFT		○	40
		PRE-SHAFT		○	3
		SHAFT-HOOK		○	12
		PRE-QUICK QUICK-KIT		○ ○	7 12
		QUICK-HOOK		○	7



● Standard ○ Optional -- Not available \* Details see page 27 \*\* Depending on the condition of the load (size, bundling, surface)



## ADDITIONAL EQUIPMENT

### OW1800 Opening width 1800 mm

Increasing the opening width from 1400 mm to 1800 mm



### UKV Tilting device

To reduce the total vehicle height.  
Only available at SHAFT

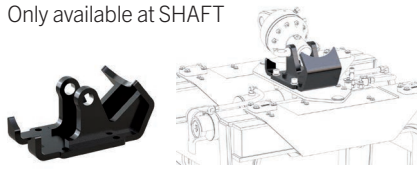

### ADRING Adapter for concrete pipes

with diameter from 800 – 1350 mm



### PENDLB Pendulum brake

The pendulum brake dampens the swinging of the crane tool



### KA Height reduction link

To reduce the total vehicle height.

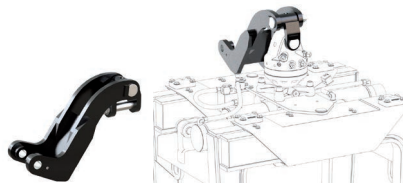

### [RAL\_\_\_\_] Special color RAL

Color different from standard color RAL7001



## COMPRESSION RAIL SET

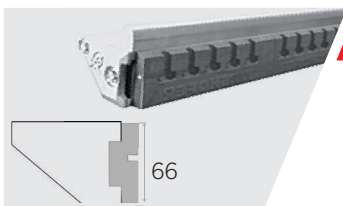

### A29

With smooth rubber  
Ideal for pallets and brick packages

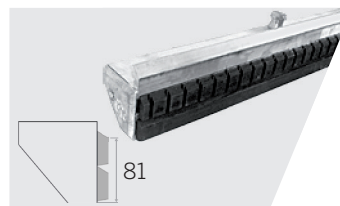

### A39

Blocked out with two rubber inserts at the top, smooth at the bottom  
Ideal for pallets and brick packages



### A32

Slat rails with lever lock and individually guided clamps  
Ideal for paving stones

# BRICK STACK GRAPPLER CONFIGURATION OPTIONS



OPTION	DESCRIPTION	CODE	PZS-S			PZS321 (NON-CE)		
<b>Basisdaten</b>	Working pressure max. [bar]		370			210		
	Overpressure protection		●			●		
	Recommended rate of flow [l/min]		25 – 75			25 – 75		
			Load capacity [kg]Opening width [mm] Weight [kg]			Load capacity [kg]Opening width [mm]Weight [kg]		
<b>Plunge depth</b>	<b>Fix</b>							
	1000 mm	FIX100	○ 2000	220 – 1420	315	--		
	1100 mm	FIX110	○ 2000	160 – 1450	320	--		
	1200 mm	FIX120	○ 1800	98 – 1475	325	--		
	1300 mm	FIX130	○ 1600	40 – 1500	330	--		
	<b>Variable</b>							
	790 – 1310 mm	VAR131	--			● 2000 – 1500	780 – 1400	401
<b>Additional equipment</b>	weld-on hook (4 pcs.)	WHOOK04		○		--		
	Pendulum brake	PENDLB		○		○		
	Tilting device for reducing the vehicle height	UKV		○		○		
	Height reduction link for reducing the vehicle height	KA		○		○		
	hydraulic plug in couplings	2RO-PK		○		○		
	Special color	RAL_----		○		○		
<b>Compression rail set</b>	With smooth rubber insert	A40	720	Length [mm] 1000	1250	Length [mm]		
	With three-piece smooth rubber insert		--	●	○	--		
<b>Crane connection*</b>						Weight [kg]		
	FLANGE		○		39	○	39	
	SHAFT		○		40	○	40	
	PRE-SHAFT		○		3	○	3	
	SHAFT-HOOK		○		12	○	12	
	PRE-QUICK		○		7	○	7	
	QUICK-KIT		○		12	○	12	
	QUICK-HOOK		○		7	○	7	



● Standard ○ Optional -- Not available \* Details see page 27 \*\* depending on the condition of the load (size, bundling, surface)





## ADDITIONAL EQUIPMENT

### UKV Tilting device

To reduce the total vehicle height.  
Only available at SHAFT

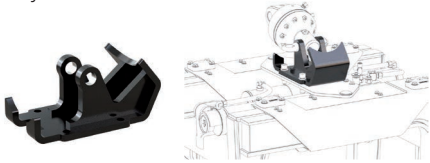

### KA Height reduction link

To reduce the total vehicle height.

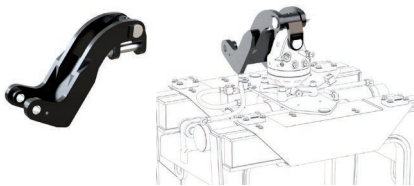

### WHOOK04 Welding hooks

4 pcs. Welding hooks for hanging slings or chains.  
(Max. load per hook is 1000 kg)



### PENDLB Pendulum brake

The pendulum brake dampens the swinging of the crane tool.



### RAL\_\_\_\_\_ Special color RAL

Color divergent from standard color RAL 7001.



# PALLET FORKS

Equipped with the right crane fork, your crane becomes an all-rounder for the handling of palletized and packaged goods. For classic pallet handling, we offer optional crane forks with mechanical, spring- or hydraulic-assisted center of gravity compensation.



## SPRING-SUPPORTED PALLET FORKS

### Comfortable PZP-V | PZP-VS

- Low-maintenance and time-saving solution
- Easy and safe picking up of pallets because of the self-adjusting center of gravity compensation
- Multifunctional use for pallet handling thanks to simple adjustment of effective height and tine distance
- Easy threading through the narrow forged tines



## MECHANICAL PALLET FORKS

### Solid PZP | PZP-MF

- Robust and economical solution
- Easy threading through the narrow forged tines
- Multifunctional use by simple adjustment of effective height and tine distance



## HYDRAULIC PALLET FORK

### Precise PZP-H

- The flexible premium product
- Fast and efficient picking up of different pallet sizes and weights
- Highest safety and precision thanks to the hydraulic balance compensation
- Simple 1-person operation saves time and money



## SPECIAL PALLET FORKS

### Individually

- In addition to the standard models, Palfinger offers a large number of special solutions on request.

# PALLET FORK CONFIGURATION OPTIONS



OPTION	DESCRIPTION	CODE	HYDRAULIC			SPRING			
			PZP-H			PZP-V			
<b>Basic data</b>	Working pressure max. [bar]		200			--			
	Overpressure protection		--			--			
	Recommended rate of flow [l/min]		40 – 75			--			
	effective depth [A]		1050 – 1650			1050 – 1650			
<b>Load capacity</b>	Center of gravity distance 500 mm	1500 kg 980 mm	TRAGL 1500 LFORK 980	○ 165	475 – 815	80x35	○ 130	475 – 815	80x35
		2000 kg 980 mm	TRAGL 2000 LFORK 980	○ 190	475 – 835	100x35	○ 150	495 – 835	100x35
		2500 kg 980 mm	TRAGL 2500 LFORK 980	○ 250	490 – 830	90x40	○ 210	490 – 830	90x40
	Center of gravity distance 600 mm	1500 kg 1150 mm	TRAGL 1500 LFORK 1150	○ 195	495 – 835	100x35	○ 165	495 – 835	100x35
		2000 kg 1150 mm	TRAGL 2000 LFORK 1150	○ 250	500 – 840	90x40	○ 205	500 – 840	90x40
		2500 kg 1150 mm	TRAGL 2500 LFORK 1150	○ 270	510 – 850	100x45	○ 230	510 – 850	100x45
<b>Additional equipment</b>	Increase of usable height in 750 mm	EXT075	○			○			
	Telescopic to useable height 2500 mm	TELE25	○			○			
	Telescopic to useable height 3000 mm	TELE30	--			--			
	Hydraulic plug in couplings	2RO-PK	○			--			
	Special color RAL	RAL_---	○			○			
<b>Crane connection*</b>			Weight [kg]			Weight [kg]			
	FLANGE		○	39		--	39		
	SHAFT		○	40		○	40		
	PRE-SHAFT		○	3		--			
	SHAFT-HOOK		○	12		○	12		
	SHAFT-LINK		○	9		○	9		
	PRE-QUICK		○	7		--			
	QUICK-KIT		○	12		--			
	QUICK-HOOK		○	7		--			



● Standard ○ Optional -- Not available \* Details see page 27 \*\* Only on load capacity 2000 kg

## ADDITIONAL EQUIPMENT

### Increase of usable height EXT075

Increase the effective height of the crane fork by 750 mm with the simple installation of the extension. Ideal for manipulating insulation materials and similar.



### Telescopic TELE25 | TELE30

Increase the usable height of the crane fork by pulling out the telescope. Efficient, without installing or removing extensions. Ideal for handling of insulation materials.





SUPPORTED			MECHANICALLY					
PZP-VS			PZP			PZP-MF		
--	--	--	--	--	--	--	--	--
1050 – 1650			1050 – 1650			1050 – 1650		
Weight [kg]	Tine distance [mm]	Cross section [mm]	Weight [kg]	Tine distance [mm]	Cross section [mm]	Weight [kg]	Tine distance [mm]	Cross section [mm]
○ 135	325 – 920	80x35	○ 120	325 – 920	80x35	--		
○ 155	345 – 940	100x35	○ 130	345 – 940	100x35	○ 150	330 – 930	100x35
○ 180	355 – 945	90x40	--			○ 180	330 – 930	100x35
○ 170	345 – 840	100x35	--			--		
○ 200	355 – 945	90x40	--			--		
○ 225	385 – 975	100x45	--			--		
	○			○			○	
	--			--			○**	
	--			--			○**	
	--			--			--	
	○			○			○	
	Weight [kg]			Weight [kg]			Weight [kg]	
--	39		--	39		○	39	
○	40		○	40		○	40	
--	3		--	3		○	3	
○	12		○	12		○	12	
○	9		○	9		○	9	
--			--			○	7	
--			--			○	12	
--			--			○	7	

Rigid link  
**SHAFT-LINK**

Payload 4500 kg  
Torsionally stiff suspension link.  
"The" addition to the spring-loaded crane fork for a more comfortable positioning of the loads

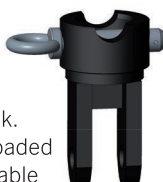

**Protective cage**

On request, a protective cage for securing loose loads on the crane forks is available. When handling loose material, a protective cage or net for load protection is mandatory (EN 13155). The maximum load capacity is 2000 kg.

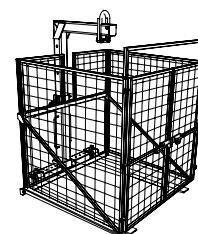

# UNIVERSAL FORK

The universal fork is particularly suitable for feeding old and new buildings with construction panels and other horizontally delivered building materials.

Different tine adjustment allows adjustment to the transported panels.

Of course, the universal fork can be used as classic crane fork.



## SINGLE SPAR

**Light**  
**PZP-W**

- Gentle handling of the plates with special tines
- Higher range due to lower weight



## DOPPELHOLM

**Robust**  
**PZP-WK**

- Gentle handling of the plates with special tines
- Robust design
- Tilting cylinder protected from damage by the double spar

# CONFIGURATION OPTIONS

OPTION	DESCRIPTION	CODE	PZP-W		PZP-WK	
<b>Basic data</b>	Working pressure max. [bar]		370		370	
	Overpressure protection		●		●	
	Recom. rate of flow [l/min]		40 - 75		40 - 75	
	Package height max. [mm]		1250		1250	
	Package depth max. [mm]		460		460	
	Tine length [mm]		1600		1600	
<b>Load capacity</b>	800 kg	TRAGL 800	Weight [kg]	Tine distance [mm]	Weight [kg]	Tine distance [mm]
			--		○ 265	600 – 1000
	1000 kg	TRAGL 1000	--		○ 340	640 – 1600
	1500 kg	TRAGL 1500	○ 345	640 – 1600	○ 380 ○ 390 ○ 395	640 – 1600 640 – 1830 640 – 2100
	2000 kg	TRAGL 2000	○ 360	640 – 1600	○ 390 ○ 400 ○ 405	640 – 1600 640 – 1830 640 – 2100
	2500 kg	TRAGL 2500	○ 380	640 – 1600	○ 400 ○ 410 ○ 415	640 – 1600 640 – 1830 640 – 2100
<b>Additional equipment</b>	Hydraulic plug in couplings	2RO-PK		○		○
	clamping device	PZP001		○		○
	Park console	PZP002		○		○
	prep. for hydraulic hook	P-PZHH		○		○
	Special color	RAL____		○		○
<b>Crane connection*</b>				Weight [kg]		Weight [kg]
	FLANGE		○	39	○	39
	SHAFT		○	40	○	40
	PRE-SHAFT		○	3	○	3
	SHAFT-HOOK		○	12	○	12
	PRE-QUICK		○	7	○	7
	QUICK-KIT		○	19	○	19
	QUICK-HOOK		○	7	○	7



● Standard ○ Optional -- Not available \* Details see page 27

## ADDITIONAL EQUIPMENT

### PZP001

Adjustable clamping device to secure single sheets and smaller packs (for load over 1000 kg)

### PZP002

Rack for safe and easy handling of folded universal fork (for load over 1000 kg)

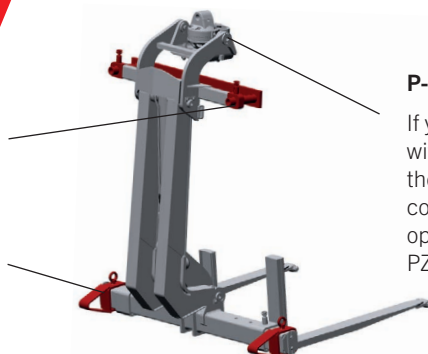

### P-PZHH

If your universal fork is equipped with P-PZHH instead of a rotator, the universal fork can also be convenient and highly efficient operated with the hydraulic hook PZHH05.



# CONTAINER DISCHARGE UNITS

The essential factor when discharging recycling bins include safety and speed. Through the precise handling of the crane, the automatic stroke limitation and the integrated pendulum brake, the driver receives a complete solution that allows him to keep an eye on the environment. This is a plus in terms of safety especially when careless passers-by are involved

Efficient operation of the implement is made possible by economical one-person operation and short cycle times. The emptying devices are available for ring- and the mushroom-system.



## MUSHROOM- OR RING SYSTEM

### PZC251 | PZC451

- For the first time also available as a 4.5 t variant
- Save time with the shorter emptying cycle
- Extremely compact and robust construction
- The optional pendulum brake ensures precise positioning at low swinging.
- The integrated pressure relief valve ensures safe working even with higher operating pressure of the crane.



## MUSHROOM SYSTEM

### PZC250PR

- Robust mechanism with automatic centering and hydraulic locking
- The pendulum brake and the flange rotator ensure precise positioning with minor fluctuations.
- The integrated pressure relief valve ensures safe working even at higher operating pressure of the crane.





## MUSHROOM- AND RING SYSTEM



### PZC250PR

- The ideal solution for recycling companies that need to empty both conventional ring system containers and mushroom-type containers.
- Compact construction and therefore low overall height
- The standard pendulum brake and the flange rotator ensure precise positioning with minor fluctuations.
- The integrated pressure relief valve ensures safe working even at higher operating pressure of the crane.

## RINGSYSTEM



### PZC250R

- PALFINGER offers two discharge units especially for containers with ring systems.
- On the one hand the compact PZC220R and the simpler PZC250R.
- Both are characterized by a robust and durable mechanism and, like all PALFINGER discharge units, also have an integrated pendulum brake and a flange rotator.

# DISCHARGE UNIT CONFIGURATION OPTIONS



OPTION	DESCRIPTION	CODE	PZC251	PZC451	PZC250PR
<b>Basic data</b>	Load capacity [kg]		2500	4500	2500
	Working pressure max. [bar]		350	350	370
	Overpressure protection		●	●	●
	Recommended rate of flow [l/min]		40	40	25 – 70
	Height [mm] (incl. Rotator)		1160	1160	1055
	Lift of the hook max. [mm]		500	500	500
	Weight [kg] (incl. Rotator an hoses)		178	178	180
<b>Additional equipment</b>	Containersystem:				
	double ring system (parallel)	RING2P	●	●	●
	mushroom system	MUSHRO	○	--	●
	Pendulum brake	PENDLB	○	○	●
	Hook and support	PZCDD	--	--	○
	Docking device	PZZC-HS	--	--	○
<b>Crane connection</b>	Crane connection	RAL_____	○	○	--
		FLANGE	○	○	●*
		SHAFT	○	○	--
		PRE-SHAFT	○	○	--
		SHAFT-HOOK	○	○	--
		PRE-QUICK	○	○	--
		QUICK-KIT	○	○	--
		QUICK-HOOK	○	○	--



● Standard ○ Optional -- Not available  
\* incl. upper suspension, without connection hoses



**PZC250P**

**PZC250R**

2500	2500
370	370
●	●
25 – 75	25 – 75
1490	1400
500	500
210	135

--	●
●	--
●	○
○	○
○	--
--	--
●*	●*
--	--
--	--
--	--
--	--
--	--
--	--

**ADDITIONAL EQUIPMENT**

**DOUBLE RING-SYSTEM [RING2P]**

Safe operation of the container discharge unit can only be ensured if the containers are equipped with the rings in the appropriate distance and dimension.

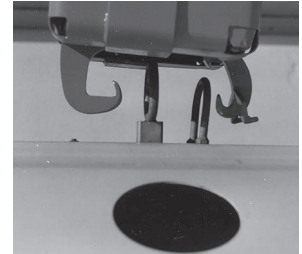
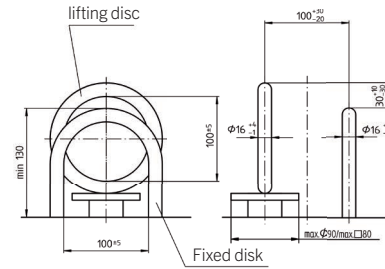

**MUSHROOM-SYSTEM [MUSHRO]**

Safe operation of the container discharge unit can only be guaranteed if the containers are equipped with the corresponding original lifting and fixed disks. These are available on request

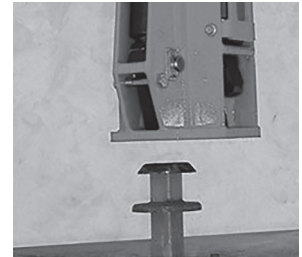
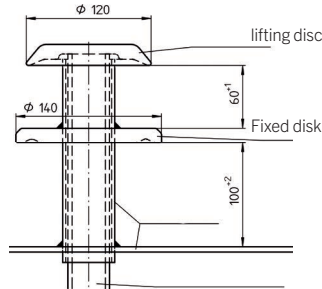

**PENDULUM BRAKE [PENDLB]**

The pendulum brake dampens the swinging of the container discharge unit and is therefore a must for a fast and precise working



**HOOK AND SUPPORT [PZZC-HS]**

To allow a temporary crane hook operation, a suitable hook with a transport support is available. The support is picked up like a container and can then be used as a hook.

Payload [kg]	2500
Weight [kg]	14

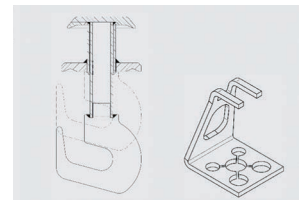

**DOCKING DEVICE [PZCDD]**

A docking device is available for all container discharge units. By using a hydraulic cylinder, the discharge unit is applied to the extension boom. In the unlocked state, the device acts as a hydraulic pendulum brake. The integrated solenoid valve allows the switching of the hydraulic circuit.

Working pressure max. [bar]	280
Folding angle [°]	90
Weight [kg]	70

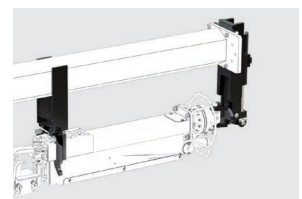

# EARTH AUGER

You need foundations for a carport, a mast or a street sign? With the earth auger as a tool for your loader crane, this work can be done in the shortest time and without any additional use of excavators. Whether earth, gravel or slightly rocky ground - with the right drill teeth, the auger becomes an all-rounder.

With minimal effort, you drill holes with the necessary diameter - without the annoying and material-intensive slope angle that results from classic digging work.



## BEG

### Auger drive

- Highest drilling performance and durability are the hallmark of the auger drives, which produce torque from 925 to 7500 Nm.
- The integrated NDS - Non-Dislagement Shaft - prevents the shaft from falling out at any time. An absolute must for work safety.
- An integrated service port allows fast and easy oil changes.
- No leak oil line necessary.



## EBG AND BEG12

### Augers and extensions

- The augers are available with a diameter of 150 to 900 mm.
- The attachment to the auger drive is easy by means of bolts.
- Depending on the crane geometry, the corresponding extensions allow a drilling depth up to 7 m - with a diameter up to 600 mm.



## EBG 077

### Drilling teeth

- Optimum drilling properties due to subsoil-specific drill teeth for earth, gravel and stony soils.
- The connection between tooth and auger varies depending on the tooth and aims for maximum durability and easy serviceability.

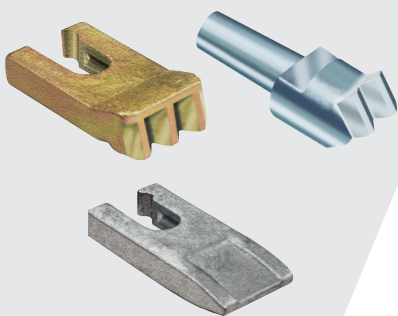

## BEGAV20

### Docking device

- The docking device with specially adapted augers drills facilitates the safe placement of the auger.
- It reduces downtime for dismantling and reinstalling the auger when changing tools or when hook operation in between.

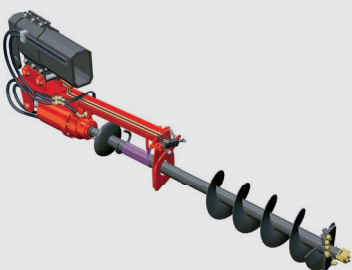

This requires a technical clarification with PALFINGER!

# POSSIBLE COMBINATIONS

## SELECTION OF THE APPLICATION

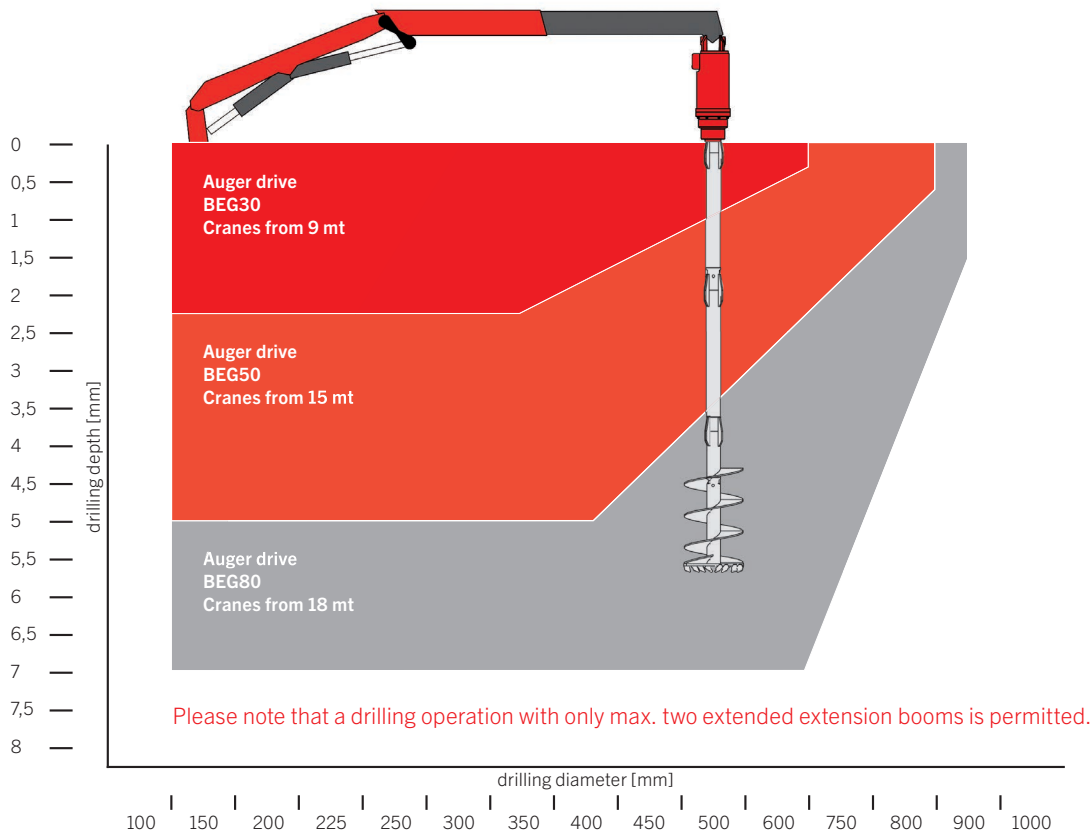

## PULL IN PARTS

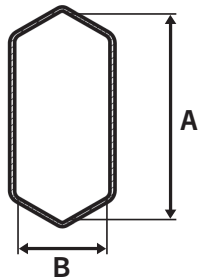
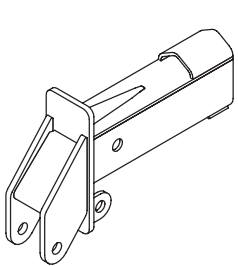

Depending on the extension boom design, adaption work may be required.

Code	Weight [kg]	Hexagonal extension boom	
		A [mm]	B [mm]
UL146	32	123	62
UL147	34	155	79
UL028	35	185	80
UL148	37	188	96
UL027	39	221	97
UL149	42	224	116
UL026	44	259	115
UL150	46	260	136
UL025	49	296	133

## AUGER DRIVE

### TECHNICAL DATA

#### BEG30

#### BEG50

#### BEG80

For operation, one hydraulic circuit on the crane is necessary!

Drilling diameter	[mm]	150 – 600	150 – 800	150 – 1000
Working pressure	[bar]	80 – 260	80 – 260	80 – 260
Overpressure protection		●	●	●
Recommended rate of flow	[l/min]	20 – 50	20 – 50	20 – 50
Drive torque*	[Nm]	925 – 3007	1542 – 5012	2313 – 7517
Rotation speed	[U/min]	27 – 68	16 – 41	11 – 27
Weight	[kg]	73	94	97

\* The maximum drive torque must not exceed the half of the crane slewing torque.

● Standard ○ Optional -- Not available

# AUGER EXTENSION



Length C [mm]	shaft length [mm]	Shaft exit [mm]	Weight [kg]	Code
500	114	□ Square 57	18	BEG12-500
1000	114	□ Square 57	25	BEG12-1000
1500	114	□ Square 57	26	BEG12-1500
2000	114	□ Square 57	30	BEG12-2000

# AUGER

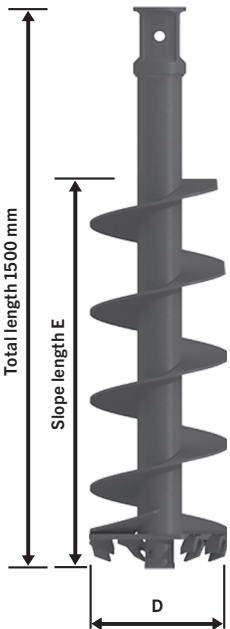

Drilling diameter D [mm]	Slope length E [mm]	Weight [kg]	Code				
			Earth and clay	dry and hard surfaces, gravel layers	Number of drilling teeth	Soft rock	Number of drilling teeth
150	1080	36	EBG150E	EBG150T	--	EBG150R	--
200	975	42	EBG200E	EBG200T	2	EBG200R	3
225	975	46	EBG225E	EBG225T	2	EBG225R	4
250	965	47	EBG250E	EBG250T	2	EBG250R	4
300	900	53	EBG300E	EBG300T	4	EBG300R	5
350	900	58	EBG350E	EBG350T	4	EBG350R	6
400	875	63	EBG400E	EBG400T	5	EBG400R	7
450	750	68	EBG450E	EBG450T	6	EBG450R	8
500	750	75	EBG500E	EBG500T	6	EBG500R	9
600	750	86	EBG600E	EBG600T	8	EBG600R	11
750	700	103	EBG750E	--	9	--	--
800	700	118	EBG800E	EBG800T	9	EBG800R	15
900	700	138	EBG900E	EBG900T	10	EBG900R	17

# WEAR PARTS

Ground	Drilling tooth	Code	Auger pilot	Code
Earth and clay		EBG 077E		EBG 077EH
dry and hard surfaces, gravel layers (Tungsten-Universal)		EBG077T		EBG 077TH
Soft rock, asphalt		EBG 077R		EBG 077RH

# HYDRAULIC HOOK

The PALFINGER hydraulic crane hooks allow the crane hook to be opened and locked using crane hydraulics and have been specially developed for applications in construction and transport as well as recycling applications. In the installation use, they facilitate the positioning and suspension of loads in exposed areas.

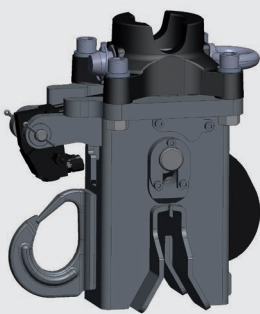

## PZHH05

- Save time by simply and safely releasing loads at exposed points
- Increase occupational safety by simplifying work processes, such as the possibility of attaching and detaching pallets or universal forks without having to climb onto the platform of the vehicle
- Optimum connection to the rotators, as well as to PALFINGER pallet and universal forks
- The weld-on hook makes it easy to attach bulky goods and big bags



## PZC250CH

- Quick and accurate attachment and detachment of containers or loads with eyelets
- Thanks to the compact design a low overall height is reached
- The robust mechanism with hydraulic cylinder ensures the opening and closing of the load hook
- The V-shaped cut-out on the hook facilitates ring reception





**OPTION**

**DESCRIPTION**

**PZHH05**

**PZC250CH**

**Basic data**

Load capacity [kg]	4500	2500
Working pressure max. [bar]	370	200
Overpressure protection	--	●
Recommended rate of flow [l/min]	2 – 10	2 – 10
Ring diameter max. [mm]	30	38
Weight [kg]	21	46

**Additional equipment**

Hose protection	--	PZZR450S
-----------------	----	----------

**Crane connection\***

Prepared for shaft rotator (PZZR450R-68)	●	--
With flange rotator (PZR450GF)	--	●

● Standard ○ Optional -- Not available \* Details see page 27

**TECHNICAL DATA**

**PZHH05**

**PZC250CH**

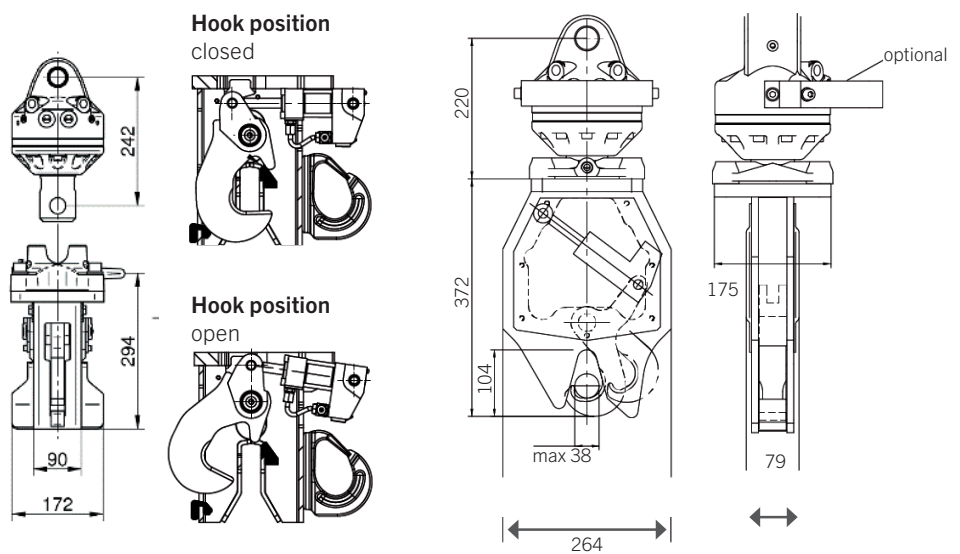

**ADAPTER PLATE FOR UNIVERSAL FORK**

If your universal fork is equipped with the adapter (P-PZHH) instead of a rotator, the universal fork can also be operated comfortably and highly efficiently with the hydraulic hook PZHH05.



# LIFTING ACCESSORY PACKAGE

Anyone moving loads with a loader crane every day, expects safety, comfort and efficiency. With one of our two special packages, made of components of the highest safety and long life, we fulfill these expectations 100%.



## PZ-BASIC

4 round slings 3-layer – 2 t – length 2 m

4 round slings 3-layer – 2 t – length 4 m

2 round slings 3-layer – 3 t – length 3 m

2 round slings 3-layer – 4 t – length 3 m

4 bow shackles high strength cap. 3250 kg

4 bow shackles high strength cap. 4750 kg

2 bow shackles high strength cap. 6500 kg

1 chain sling 3.55 t – 4.5 m - shortenable

## PZ-PREMIUM

4 round slings 3-layer – 2 t – length 2 m

4 round slings 3-layer – 2 t – length 4 m

2 round slings 3-layer – 3 t – length 3 m

2 round slings 3-layer – 4 t – length 3 m

2 load hooks for round slings – 2 t

2 load hooks for round slings – 3 t

4 bow shackles high strength cap. 3250 kg

4 bow shackles high strength cap. 4750 kg

4 bow shackles high strength cap. 6500 kg

2 chain slings 3.55 t – 4.5 m - shortenable

2 lifting belts – 3 t – length 5 m

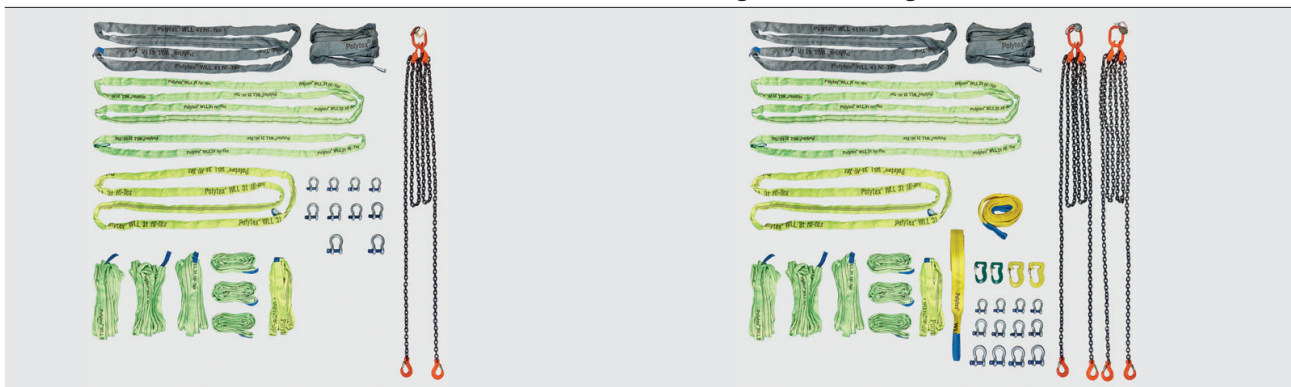

Both packages contain surprise presents from our promotion assortment

(Pictures are just sample pictures)

Discover more products in our promotion online shop [palfinger.com](http://palfinger.com)

# BARRIER LIFTER

The barrier lifter is the perfect tool for manipulating concrete barriers. The mechanical clamping system with gripping jaws made of diamond carbide enables efficient one-person operation. By simply repositioning the locking pin various clamping ranges can be adjusted. Since no oil supply is required for this system, it is cost-effective to retrofit almost every crane.



## TECHNICAL DATA

### PZB932-6/10

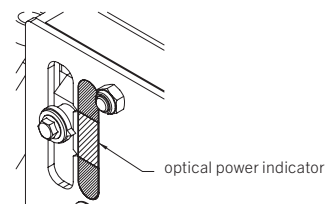
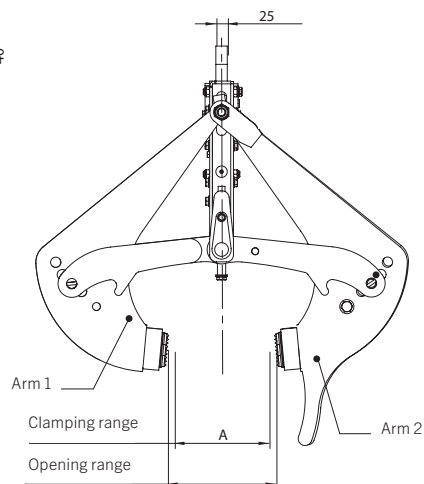
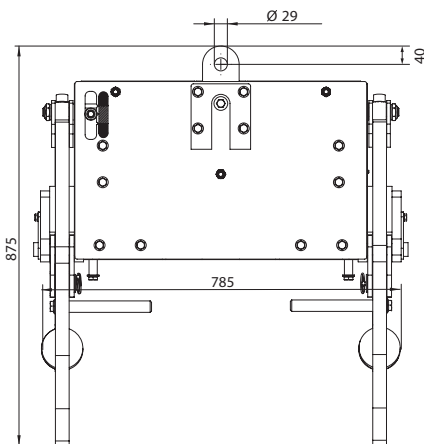

### PZB932-12/14

Clamping range A	[mm]	115 – 305	295 – 395
Load capacity	[kg]	6580	6580
Weight	[kg]	162	150



# CAR LIFTING DEVICES

The car lifting devices which are designed for daily use ensure easy loading and unloading of vehicles up to max. 3.5 t. In addition, they offer optimum protection against damage due to the possibility of individual adaptability to the respective vehicle.

OPTION	DESCRIPTION	CODE	3.5 t
			<b>PZLG35PK</b>
<b>Basic data</b>	lifting system		With rotator connection for rotary motion and hydraulic center of gravity compensation (2 hydraulic circuits on the crane required)
<b>Technical data</b>	Load capacity [kg]		3500
	Working pressure max. [bar]		210
	Overpressure protection		--
	Weight [kg]		185
<b>Additional equipment</b>	Radklammernset für Reifenbreite 355 mm	PZTC01-1	●
	Hebegurtset	PZLS01	●
	Halterung für Montage am Fahrzeug	PZLG35B PZLG20B	● --
<b>Crane connection</b>	Flange rotator package		● Suitable flange rotator, connecting hoses, upper suspension (UL045)
● Standard   ○ Optional   -- Not available			<div style="display: flex; justify-content: space-around;"> <div style="text-align: center;"> <p>Transport position</p>  </div> <div style="text-align: center;"> <p>Working position</p>  </div> </div>



**2.0 t**  
**PZLG20HPK**

With hook connection

(no hydraulic circuit on the crane required)

2000

--

--

85

●

●

--

○

-- (Crane hook)

Transport position

Working position



**ADDITIONAL EQUIPMENT**

Wheel clamp set consists of 4 wheel clamps

**PZTC01-1**

Load capacity	900 kg / Clamp
Tire width	355 mm
Wheel size	12 – 19 inch
Weight	17 kg



Hoisting sling set consists of 4 hoisting slings

**PZLS01**

Load capacity	892 kg / Hoisting sling		
Length (adjustable)	1.3 m	1.5 m	1.7 m
Width	50 mm		



Bracket for mounting on the vehicle

**PZLG35B / PZLG20B**

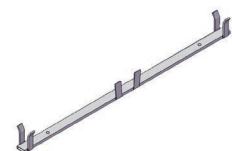

# MANIPULATORS

- The manipulator is ideal for lifting and positioning pipes and masts.
- Agility because of three hydraulic functions: gripping, turning and swiveling (third hydraulic control circuit or electric changeover valve required) and endless swivel range for efficient operation
- High payloads from 500 kg to 3000 kg
- Precise positioning by the rotator with mechanically acting, hydraulically-releasable brake for rotary motion
- A combination of manipulator and auger is available on request.

## TECHNICAL DATA

### PZM 500

### PZM1000

### PZM2000

### PZM3000

We, at PALFINGER, are happy to assist you to create a complete system

	PZM 500	PZM1000	PZM2000	PZM3000
Load capacity [kg]	500	1000	2000	3000
Working pressure max. [bar]	200	200	250	250
Overpressure protection	--	--	--	--
Recommended rate of flow [l/min]	20 – 40	20 – 40	20 – 40	20 – 75
Closing force [kN]	11	23	32	62
Number of gripper arms	1	2	4	6
Pipe diameter [mm]*	175 – 300	100 – 300	250 – 600	250 – 600
Overall width [mm]	785	1300	1300	2560
Swivel range	continous	continous	continous	continous
Weight [kg]	235	310	910	1360

\* Other pipe diameters are available on request.

Tubes or poles have to be grabbed always in the center of gravity!

## OPTIONS

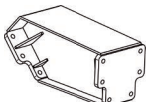
Changeover valve for 3rd control circuit	PZMMV (24V) PZMMV-12V (12V)	PZMMV (24V) PZMMV-12V (12V)	PZMMV (24V) PZMMV-12V (12V)	PZMMV (24V) PZMMV-12V (12V)
45° Adapter 	PZMA45	PZMA45	PZMA45-2	PZMA45-2

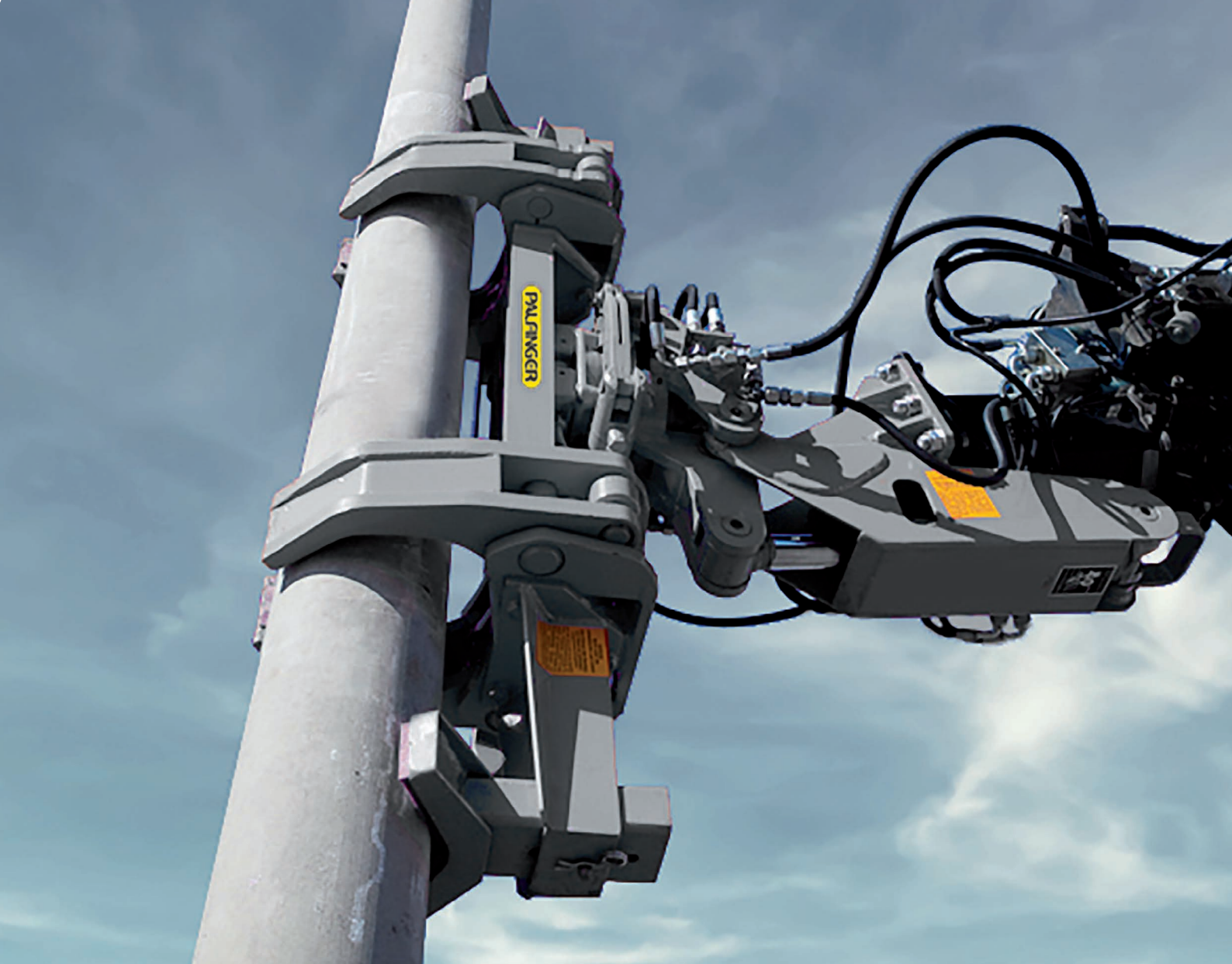

**PULL IN PARTS**      **PZM 500**      **PZM1000**      **PZM2000**      **PZM3000**

For hexagonal extension boom				Weight [kg]
A [mm]	B [mm]			
123	62	BB040ES01AU		37
155	79	BB040ES02AU		40
188	98	BB040ES03AU		40
188	98	BB040ES04AU		40
224	120	BB040ES05AU	HXE7196	43
260	138	BB040ES06AU		44
296	158	BB040ES08AU		48
237	146	BB040ES09AU		52
282	170	BB040ES015AU		55
327	198	BB040ES016AU		57

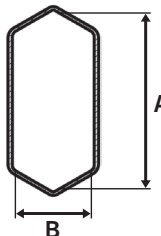

We offer pull in parts on request that are specially adapted to crane and manipulator

**SPECIAL APPLICATIONS**



# SPECIAL LOAD ATTACHMENT

Suitable for a variety of cranes, the special load suspension allows trouble-free working in all arm positions. The shackle is included. The simple mounting on the hexagonal crane arm and the possibility of mounting a PALFINGER rotator are further advantages.

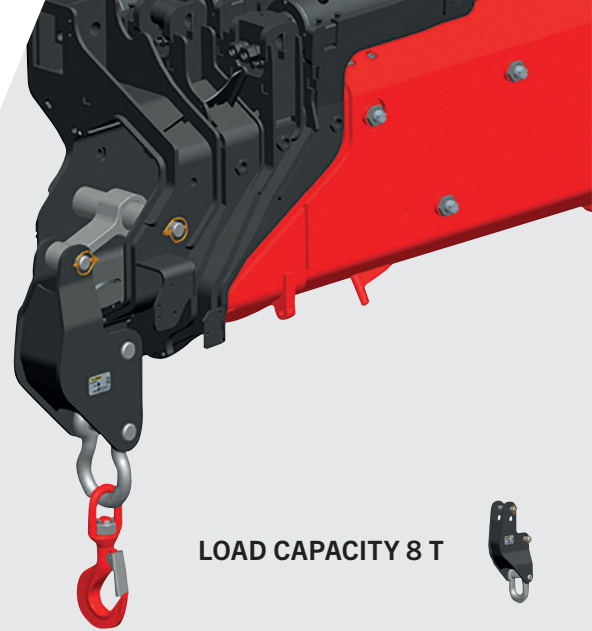

LOAD CAPACITY 8 T

LOAD CAPACITY 15 T

## CRANE TYPES

### Hydraulic extension on the crane

	A	B	C	D	E	F	G	H
PK 8.501 / 9.001 / 9.501 SLD	KMG03659A	KMG03661A	KMG03661A	KMG03661A				
PK 8502 / 9002-EH / 10002-SH	KMG03659A	KMG03661A	KMG03661A	KMG03661A				
PK 11.001 / 12.001 / 12.501 SLD	KMG03659A	KMG03661A	KMG03661A	KMG03661A				
PK 11002 / 12002-EH / 12502-SH	KMG03659A	KMG03661A	KMG03661A	KMG03661A				
PK 13.501 / 14.001 / 14.501 SLD	KMG03664A	KMG03663A	KMG03660A	KMG03661A	KMG03661A			
PK 13002 / 14002-EH / 14502-SH	KMG03664A	KMG03663A	KMG03660A	KMG03661A	KMG03661A			
PK 17.001 / 18.001 / 19.001 SLD	KMG03664A	KMG03663A	KMG03660A	KMG03661A	KMG03661A			
PK 16002 / 18002-EH / 18502-SH	KMG03664A	KMG03663A	KMG03660A	KMG03661A	KMG03661A			
PK 21.501 / 22.501 / 24.001 SLD	KMG03664A	KMG03660A	KMG03660A	KMG03661A	KMG03661A			
PK 23002-SH	KMG03664A	KMG03660A	KMG03660A	KMG03661A	KMG03661A			
PK 19502 / 22002-EH	KMG03664A	KMG03660A	KMG03660A	KMG03661A	KMG03661A			
PK 24001 / 24001-K / 27001-EH	KMG03658A	KMG03657A	KMG03662A	KMG03660A	KMG03660A	KMG03661A	KMG03661A	
PK 23502 / 26002-EH	KMG03658A	KMG03657A	KMG03662A	KMG03660A	KMG03660A	KMG03661A	KMG03661A	
PK 27002-SH	KMG03658A	KMG03657A	KMG03662A	KMG03660A	KMG03660A	KMG03661A	KMG03661A	
PK 30002 / 33002-EH / 34002-SH	KMG03658A	KMG03657A	KMG03662A	KMG03660A	KMG03660A	KMG03661A	KMG03661A	
PK 36502 / 41002-EH / 41002-MH	KMG03645A	KMG03653A	KMG03654A	KMG03656A	KMG03651A	KMG03655A	KMG03643A	
PK 40002-EH / 42002-SH	KMG03645A	KMG03653A	KMG03654A	KMG03656A	KMG03651A	KMG03655A	KMG03643A	
PK 44502 / 48002-EH / 48002-MH	KMG03645A	KMG03653A	KMG03654A	KMG03656A	KMG03651A	KMG03655A	KMG03643A	
PK 50002-EH / 53002-SH	KMG03645A	KMG03653A	KMG03654A	KMG03656A	KMG03651A	KMG03655A	KMG03643A	
PK 56502 / 62002-EH / 62002-MH	KMG03645A	KMG03653A	KMG03654A	KMG03648A	KMG03647A			
PK 63002-EH / 65002-SH	KMG03645A	KMG03653A	KMG03654A	KMG03648A	KMG03647A	KMG03641A	KMG03646A	
PK 76002-EH / 78002-SH			KMG03649A	KMG03648A	KMG03647A	KMG03641A	KMG03646A	
PK 88002-EH / 92002-SH			KMG03645A		KMG03644A	KMG03642A	KMG03641A	KMG03640A
PK100002 / 110002-SH			KMG03665A	KMG03666A		KMG03639A	KMG03638A	KMG03637A

## FLY-JIB TYPES

### Hydraulic extension on the fly-jib

	A	B	C	D	E	F	G	H
PJ060	KMG03643A	KMG03661A						
PJ125					KMG03661A			
PJ170					KMG07307A			



# INSTALLATION TIP

- Load capacity 6 t
- Easy installation on the hexagonal crane arm
- Shackle not included
- Ideal for working through windows or door openings due to the offset load handling point

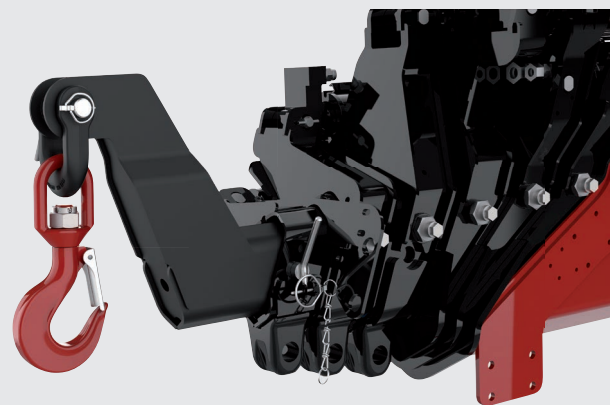

## FLY-JIB TYPES

### Hydraulic extension on the fly-jib

	A	B	C	D	E	F	G	H
<b>PJ 060</b>	KLG003ASA	KLG010ASA						
<b>PJ 080</b>		KLG011ASA	KLG010ASA					
<b>PJ 125</b>			KLG009ASA		KLG010ASA			
<b>PJ 170</b>					KLG011ASA			

\* Installation tips for use on other extension variants, both on the fly jib and on the crane, are available on request.

# WEIGHT MEASUREMENT SYSTEMS

With the PALFINGER weight measurement systems, you can weigh a wide variety of goods quickly and with the greatest possible accuracy.

Both systems have been specially designed to be robust and efficient execution. Depending on the application, we offer a load measuring shackle or the load measuring link, either with a Bluetooth app or with a radio handheld display.

## Your advantages

- Robust construction, all critical components are in a protected housing
- Ready for use anywhere thanks to the use of standard AA batteries
- Maximum battery life because of intelligent control of the radio signal
- Excellent resistance to moisture and dirt (IP67)
- Versatile display of the weighing result (tons / pounds / Kilogram / kilonewton)
- Adjustable overload alarm (visual and acoustic signal)
- All systems are delivered in a robust metal case, including Test certificate, operating instructions and initial batteries

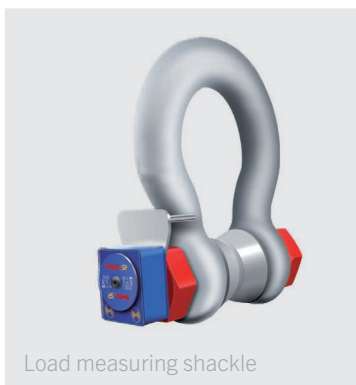

PZWMS012(-BT)



Optionally with **handheld** or **Bluetooth APP**



PZWML012(-BT)



Optionally with **handheld** or **Bluetooth APP**



**DESCRIPTION**

**PZWMS012**

**PZWML012**

**PZWMS012-BT**

**PZWML012-BT**

**Advantages**



- compact design
- easy handling
- No additional Shackle necessary



- highest measurement accuracy
- Weighing certificate +/- 0.1%
- Protected construction



- compact design
- easy handling
- No additional Shackle necessary
- For iOS or Android



- highest measurement accuracy
- Weighing certificate +/- 0.1%
- Protected construction
- For iOS or Android

**Messbereich**

1200 kg – 12000 kg

360 kg – 12000 kg

1200 kg – 12000 kg

360 kg – 12000 kg

**Accuracy**

+/- 1%

+/- 0.1%

+/- 1%

+/- 0.1%

**Units**

t / kN / kg / lb

t / kN / kg / lb

t / kN / kg / lb

t / kN / kg / lb

**Measuring grid**

10 kg

2 kg

10 kg

2 kg

**Weight**

8

3.7

8

Bluetooth

**Frequency**

2.4 GHz

2.4 GHz

Bluetooth

500h-shackle

**Battery Life**

1200h-shackle / 60h-handheld

1200h-shackle / 60h-handheld

500h-shackle

100 m

**Reach**

700 m

700 m

100 m

700 m

**Scope of delivery**

Load measuring shackle  
Centering coil  
Hand display  
Transport case  
operation manual  
Test certificate  
6 x AA batteries

Load measurement link  
Hand display  
Transport case  
operation manual  
Test certificate  
6 x AA batteries

Load measuring shackle  
Centering coil  
Free app for iOS or Android (link)  
Transport case  
operation manual  
Test certificate  
6 x AA batteries

Load measurement link  
Free app for iOS or Android (link)  
Transport case  
operation manual  
Test certificate  
6 x AA batteries

KP-CRANETOOLSM2+EN

The shown cranes are partly equipped with optional equipment and do not always correspond to the standard version. For crane construction, country-specific regulations must be observed. Dimensions are not binding. Subject to technical changes, errors and translation errors.